

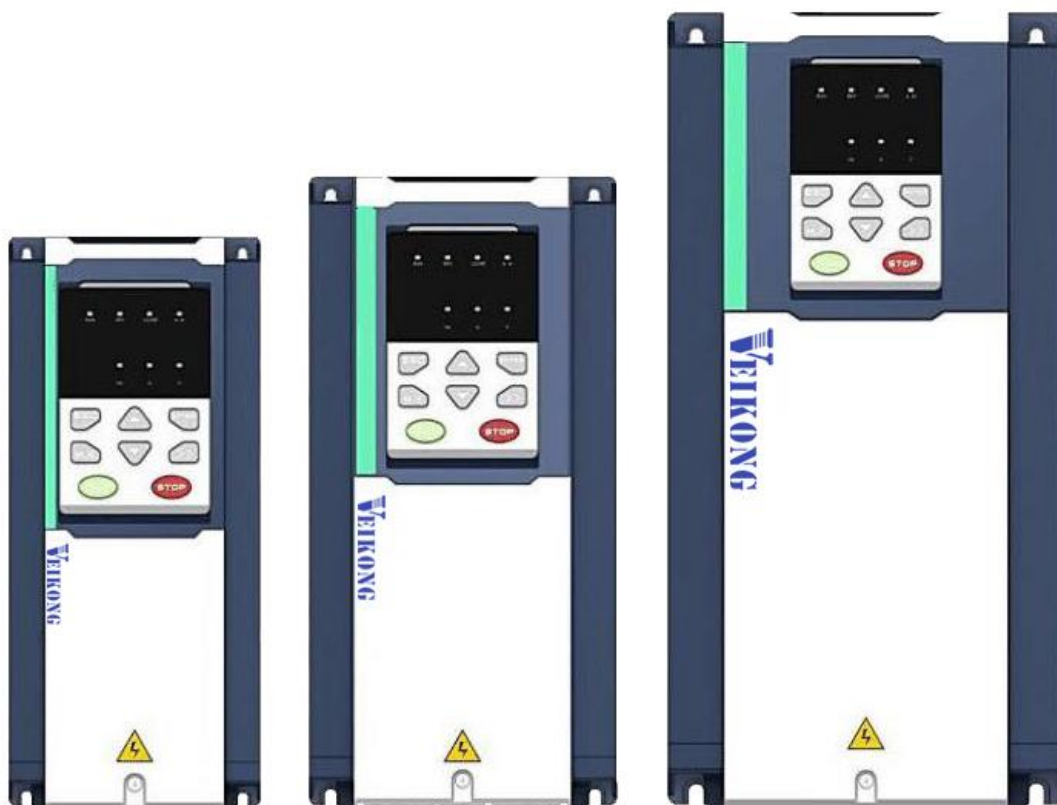

Operation user manual

VFD530 AC drive

High Performance vector and torque



Preface

Thank you for purchasing the VFD530 series high performance vector and torque control frequency inverter. VFD530 series drivers can drive both induction motors and permanent magnet synchronous motors. VFD530 series with advanced functions, such as high performance vector control of induction motor, user-programmable function and backstage monitoring software, variable communication and supporting multiple PG cards etc. It is applicable to textile, papermaking, tension control, wire drawing fans and pumps, machine tools, packaging, food and all kinds of automatic production equipment. Its excellent performance is equivalent and competitive to most of international brand AC drives

This manual introduces functional characteristics and usage of VFD530 series inverter, includes product model selection, parameter settings, running and debugging, maintenance, checking, and so on. Please be sure to read this manual carefully before operation. For equipment matching manufacturers, please send this manual to your end user together with your devices, in order to facilitate the usage.

PRECAUTIONS

- ◆ To describe the product details, the illustrations in the manual sometimes are under the state of removing the outer housing or security covering. While using the product, please be sure to mount the housing or covering as required, and operate in accordance with the contents of manual.
- ◆ The illustrations in this manual is only for explanation, may be different from the products you ordered.
- ◆ Committed to constantly improving the products and features will continue to upgrade, the information provided is subject to change without notice.
- ◆ Please contact with the regional agent or client service center directly of factory if there is any questions during usage.

EDIT: V1.0

TIME: 2021-02

Contents

Chapter 1 Safety Information and Precautions	1
1.1 Safety Precautions.....	1
1.2 Precaution	2
Chapter 2 Product Information	4
2.1 Designation Rules.....	4
2.2 Product series instruction	4
2.3 Technical Specifications.....	6
Chapter 3 Product appearance and Installation Dimension	9
3.1 Product appearance.....	9
3.1.1 Product appearance.....	9
3.1.2 Appearance and Mounting Hole Dimension	12
3.1.3 Removal and installation of cover and inlet plate	17
3.2 Wiring.....	20
3.2.1 Standard wiring diagram.....	20
3.2.2 Main Circuit Terminals.....	21
3.2.3 Terminal screws and wiring specifications	22
3.2.4 Cautions for Main Circuit Wiring.....	24
3.2.5 Control Circuit Terminal	25
3.3 EMCquestion and solution.....	31
Chapter 4 Operation and display	33
4.1 LED Instruction of operation and display	33
4.2 Display hierarchy and menu mode.....	34
4.3 Digital tube display.....	35
4.4 Test run	36
Chapter 5 Function Code Table.....	38
Chapter 6 Fault Diagnosis and Solution	122
6.1 Failure and diagnosis	122
6.2 Warning type.....	128
Chapter 7 Selection Guide of inverter Accessory	130
7.1 Selection Guide of braking component.....	130
7.2 PG card type.....	131
7.3 IO Extension card	134
7.4 CANopen exentsion card.....	136
Chapter 8 Daily maintenance of frequency inverters	139
8.1 Daily maintenance	139
8.1.1 Daily maintenance	139
8.1.2 Regular inspection.....	139
8.2 Wearing parts replacement	139
8.3 Warranty Items	140
Appendix A Modbus communication protocol	141

Chapter 1 Safety Information and Precautions

Safety Definitions: In this manual, safety precautions are divided into the following two categories:









indicates that failure to comply with the notice will result in serious injury or even death









indicates that failure to comply with the notice will result in moderate or minor injury and equipment damage

Read this manual carefully so that you have a thorough understanding. Installation, commissioning or maintenance may be performed in conjunction with this chapter. will assume no liability or responsibility for any injury or loss caused by improper operation.

1.1 Safety Precautions

Use stage	Security Level	Precautions
Before Installation	 DANGER	<ul style="list-style-type: none"> ➤ packing water, parts missing or damaged parts, please do not install! ➤ Packaging logo and physical name does not match, please do not install!
	 WARNING	<ul style="list-style-type: none"> ➤ Handling should be light lift, otherwise there is the danger of damage to equipment! ➤ Do not use damaged drive or missing drive. Risk of injury! ➤ Do not touch the control system components by hand, or there is the danger of electrostatic damage!
During Installation	 DANGER	<ul style="list-style-type: none"> ➤ Please install the flame retardant objects such as metal, away from combustibles, or may cause a fire!
	 WARNING	<ul style="list-style-type: none"> ➤ Do not allow lead wires or screws to fall into the drive, otherwise the drive may be damaged! ➤ Install the drive in a place where there is less vibration and direct sunlight. ➤ Drive placed in airtight cabinet or confined space, please note the installation of space to ensure the cooling effect.
Wiring	 DANGER	<ul style="list-style-type: none"> ➤ You must follow the guidance of this manual and be used by qualified electrical engineers. Otherwise, unexpected danger may occur! ➤ There must be a circuit breaker between the drive and the power supply, otherwise a fire may occur! ➤ Make sure the power supply is in zero-energy state before wiring, otherwise there is danger of electric shock! ➤ Please follow the standard to the drive properly grounded, otherwise there is the risk of electric shock!
	 WARNING	<ul style="list-style-type: none"> ➤ Never connect input power to the drive's output terminals (U, V, W). Note that the terminal markings, do not take the wrong line! Otherwise it will cause damage to the drive! ➤ Never connect the braking resistor directly to the DC bus +, - terminals. Otherwise it will cause a fire! ➤ Refer to the manual's recommendations for the wire diameter used. Otherwise it may happen accident! ➤ Do not disassemble the connecting cable inside the driver. Otherwise, the internal of the servo driver may be damaged.
Before Power-on	 DANGER	<ul style="list-style-type: none"> ➤ Make sure the voltage level of the input power is the same as the rated voltage of the driver. Check if the wiring position of the power input terminals (R, S, T) and output terminals (U, V, W) is correct; Of

Use stage	Security Level	Precautions
		<p>the external circuit is short-circuited, the connection is tightened, or cause damage to the drive!</p> <ul style="list-style-type: none"> ➤ No part of the drive need to withstand voltage test, the product has been made before the test. Otherwise it may cause accident!
	 WARNING	<ul style="list-style-type: none"> ➤ The driver must be covered before the cover can be powered, otherwise it may cause electric shock! ➤ All peripheral accessories must be wired according to the instructions in this manual, and be properly wired in accordance with this manual. Otherwise it may cause accident!
After Power-on	 DANGER	<ul style="list-style-type: none"> ➤ Do not open the cover after power on, otherwise there is danger of electric shock! ➤ If the indicator light does not light after power on, the keyboard does not display the situation, immediately disconnect the power switch, do not touch any input and output terminals of the drive, otherwise there is the risk of electric shock!
	 WARNING	<ul style="list-style-type: none"> ➤ If parameter identification is required, preclude the possibility of injury when rotating the motor! ➤ Do not arbitrarily change the drive manufacturer parameters, or it may cause damage to the device!
During Operation	 DANGER	<ul style="list-style-type: none"> ➤ Do not touch the cooling fan, radiator and discharge resistance to test the temperature, otherwise it may cause burns! ➤ Non-professional technicians Do not detect the signal during operation, otherwise it may cause personal injury or equipment damage!
	 WARNING	<ul style="list-style-type: none"> ➤ Drive operation, should avoid something falling into the device, otherwise it will cause damage to the device! ➤ Do not use the contactor on-off method to control the start and stop the drive, otherwise it will cause damage to the equipment!
Maintenance	 DANGER	<ul style="list-style-type: none"> ➤ Do not live on the equipment repair and maintenance, or there is a risk of electric shock! ➤ Turn off the input power for 10 minutes before performing maintenance and repair on the drive, otherwise the residual charge on the capacitor will cause harm to people! ➤ Do not carry out maintenance and repair on the drive without personnel who have been professionally trained, otherwise personal injury or equipment damage will occur! ➤ All pluggable plug-ins must be unplugged in the case of power failure! ➤ The parameters must be set and checked after replacing the drive.
	 WARNING	<ul style="list-style-type: none"> ➤ Before performing maintenance work on the drive, make sure that the motor is disconnected from the drive to prevent the motor from feeding back power to the drive due to accidental rotation.

1.2 Precaution

● Contactor using

If the contactor is installed on the power input side of the inverter, do not make the contactor frequent on-off operation. The interval between ON and OFF of the contactor should not be less than one hour. Frequent charging and discharging will reduce the use of capacitors in the inverter life.

If a contactor is installed between the inverter output terminals (U, V, W) and the motor, make sure that the inverter is turned on and off when there is no output. Otherwise, the inverter may be damaged.

● Lightning impulse protection

Although this series of inverters are equipped with lightning over-current protection device, there is a certain degree of self-protection for inductive lightning, but for lightning frequent place, customers should also install lightning protection device in the front of the inverter.

- **Altitude and derating use**

In areas above 1000m above sea level, it is necessary to derate the inverter due to poor air quality due to poor air quality. In this case, please consult our company.

- **Power input**

The inverter power input should not exceed the operating voltage range specified in this manual. If necessary, use a step-up or step-down device to change the power supply to the specified voltage range.

Do not change the three-phase inverter to two-phase input, otherwise it will cause malfunction or inverter damage.

- **Output filtering**

When the cable length between the inverter and the motor exceeds 100 meters, it is suggested to use the output AC reactor to avoid inverter over-current caused by excessive distributed capacitance. Output filter according to the needs of the field matching.

Inverter output is PWM wave, please do not install the capacitor on the output side to improve the power factor or lightning varistor, etc., otherwise it may easily lead to inverter instantaneous overcurrent or even damage the inverter.

- **About motor heat and noise**

Because the inverter output voltage is PWM wave, contains a certain degree of harmonics, so the motor temperature rise, noise and vibration compared with the same frequency operation will be slightly increased.

- **Disposal**

Electrolytic capacitors on the main circuit and electrolytic capacitors on the printed circuit board may explode when incinerated, and poisonous gases are generated when plastic parts are burned. Please dispose as industrial waste.

- **The scope of application**

This product is not designed and manufactured for use on equipment where life is at stake. To use this product on a mobile, medical, aerospace, nuclear or other special purpose device, please contact our company For more information.

This product is manufactured under strict quality control and should be equipped with a safety device if it is used in a device that may cause a serious accident or damage due to inverter failure.

Chapter 2 Product Information

2.1 Designation Rules

Name plate:

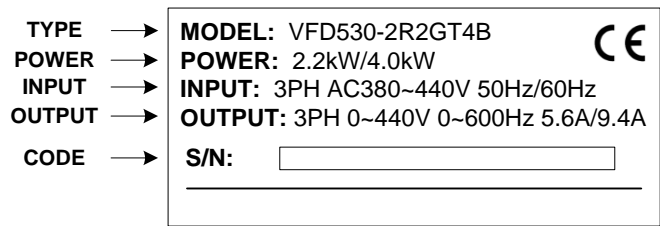

2-1 Name Plate

Model instruction:

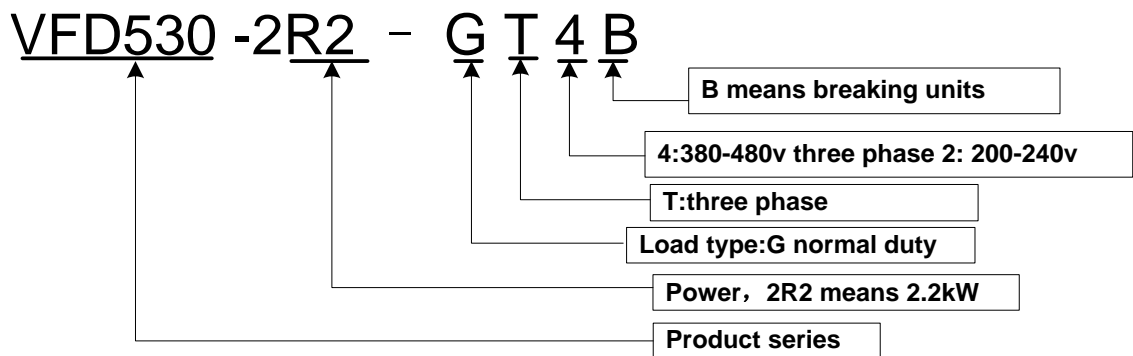

2-2 Model instruction

2.2 Product series instruction

Table 2-1VFD530 inverter models and technical data

Model	Power capacity (KVA)	Input current (A)	Output current(A)		Adaptable Motor (KW)	SIZE	Brake Unit
			Heavy load	Light load			
Three phase: 380-480V, 50/60Hz							
VFD530-R75GT4B	1.5	3.4	2.5	4.2	0.75	SIZE A	Internal
VFD530-1R5GT4B	3	5	4.2	5.6	1.5		
VFD530-2R2GT4B	4	5.8	5.6	9.4	2.2		
VFD530-4R0G/5R5PT4B	5.9	10.5	9.4	13.0	3.7		
VFD530-5R5G/7R5PT4B	8.9	14.6	13.0	17.0	5.5	SIZE B	Internal
VFD530-7R5G/011PT4B	11	20.5	17.0	23.0	7.5		
VFD530-011G/015PT4B	17	26.0	25.0	31.0	11	SIZE C	Internal
VFD530-015G/018PT4B	21	35.0	32.0	37.0	15		
VFD530-018G/022PT4B	24	38.5	37.0	45.0	18.5	SIZE D	
VFD530-022G/030PT4B	30	46.5	45.0	57.0	22		
VFD530-030G/037PT4	40	62.0	60.0	75.0	30	SIZE E	option
VFD530-037G/045PT4	50	76.0	75.0	87.0	37		
VFD530-045G/055PT4	60	92.0	90.0	110.0	45	SIZE F	
VFD530-055G/075PT4	75	113.0	110.0	135.0	55		
VFD530-075G/090PT4	104	157.0	152.0	165.0	75	SIZE G	External
VFD530-090G/110PT4	112	170.0	176.0	210.0	90		
VFD530-110G/132PT4	145	220.0	210.0	253.0	110	SIZE H	
VFD530-132G/160PT4	170	258.0	253.0	304.0	132	SIZE I	
VFD530-160G/185PT4	210	320.0	304.0	360.0	160		
VFD530-185G/200PT4	245	372.0	360.0	380.0	185	SIZE J	
VFD530-200G/220PT4	250	380.0	380.0	426.0	200		
VFD530-220G/250PT4	280	425.0	426.0	465.0	220	SIZE K	
VFD530-250G/280PT4	315	479.0	465.0	520.0	250		
VFD530-280G/315PT4	350	532.0	520.0	585.0	280	SIZE L	
VFD530-315G/355PT4	385	585.0	585.0	650.0	315		
VFD530-355G/400PT4	420	638.0	650.0	725.0	355	SIZE M	
VFD530-400G/450PT4	470	714.0	725.0	820.0	400		
VFD530-450G/500PT4	530	810.0	820.0	900.0	450	SIZE N	
VFD530-500G/560PT4	585	900.0	900.0	980.0	500		
VFD530-560G/630PT4	660	969.0	980.0	1080	560	SIZE O	
VFD530-630GT4	720	1100	1120	1260	630	SIZE O	
VFD530-710GT4	800	1245	1260	1380	710	SIZE O	
Single phase :220V ,50/60HZ							
VFD530-R40GS2	1.3	6.0	3.2	5.6	0.4	SIZE A	Inbuilt

VFD530-R75GS2	2.4	11.0	5.6	8.0	0.75	SIZE A	
VFD530-1R5GS2	5.9	15.0	8.0	10.6	1.5	SIZE A	
VFD530-2R2GS2	5.9	25.0	10.6	14.0	2.2	SIZE A	
VFD530-4R0GS2	7.7	35.0	17.0	23.0	4.0	SIZE B	
VFD530-5R5GS2	8.9	53.0	25.0	31.0	5.5	SIZE C	
VFD530-7R5GS2	11	67.0	32.0	37.0	7.5	SIZE C	
Three phase :220V ,50/60HZ							
VFD530-R40GT2B	4	6.0	3.2	5.6	0.4	SIZE A	Inbuilt
VFD530-R75GT2B	4	11.0	5.6	8.0	0.75	SIZE A	
VFD530-1R5GT2B	3.5	15.0	8.0	10.6	1.5	SIZE A	
VFD530-2R2GT2B	5.5	25.0	10.6	14.0	2.2	SIZE A	
VFD530-4R0GT2B	11	35.0	17.0	23.0	4.0	SIZE B	
VFD530-5R5GT2B	17	53.0	25.0	31.0	5.5	SIZE C	
VFD530-7R5GT2B	21	67.0	32.0	37.0	7.5	SIZE C	
VFD530-011GT2B	30	46.5	45.0	/	11	SIZE D	Inbuilt
VFD530-015GT2	40	62.0	60.0	/	15	SIZE E	External
VFD530-018GT2	50	76.0	75.0	/	18.5	SIZE E	External
VFD530-022GT2	60	92.0	90.0	/	22	SIZE F	External
VFD530-030GT2	75	113.0	110.0	/	30	SIZE F	External
VFD530-037GT2	104	157.0	152.0	/	37	SIZE G	External
VFD530-045GT2	112	170.0	176.0	/	45	SIZE G	External
VFD530-055GT2	145	220.0	210.0	/	55	SIZE H	External
VFD530-075GT2	145	320.0	304.0	/	75	SIZE I	External

Description:

* The built-in brake unit of this model is optional. Take 30kW as an example. The model without brake unit is VFD530-030G/037PT4, and the model with brake unit is VFD530-030G/037PT4B

2.3 Technical Specifications

Table 2-2 VFD530 Technical Specifications

Item		Specification
Input	Inuput Voltage	1phase/3phase 220V: 200V~240V 3 phase 380V-480V: 380V~480V
	Allowed Voltage fluctuation range	-15%~10%
	Input frequency	50Hz / 60Hz, fluctuation less than 5%
Output	Output Voltage	3phase: 0~input voltage
	Overload capacity	General purpose application: 60S for 150% of the rated current

		Light load application: 60S for 120% of the rated current
Control	Control mode	V/f control Sensorless flux vector control without PG card (SVC) Sensor speed flux vector control with PG card (VC)
	Operating mode	Speed control、Torque control (SVC and VC)
	Speed range	1:100 (V/f) 1:200(SVC) 1:1000 (VC)
	Speed control accuracy	±0.5% (V/f) ±0.2% (SVC) ±0.02% (VC)
	Speed response	5Hz(V/f) 20Hz(SVC) 50Hz(VC)
	frequency range	0.00~3000.00HZ(VF) 0.00~200.00Hz(SVC) 0.00~400.00Hz(VC)
	Input frequency resolution	Digital setting: 0.01 Hz Analog setting: maximum frequency x 0.1%
	Startup torque	150%/0.5Hz(V/f) 180%/0.25Hz(SVC) 200%/0Hz(VC)
	Torque control accuracy	SVC: within 5Hz10%, above 5Hz5% VC:3.0%
	V/f curve	V / f curve type: straight line, multipoint, power function, V / f separation; Torque boost support: Automatic torque boost (factory setting), manual torque boost
	Frequency giving ramp	Support linear and S curve acceleration and deceleration; 4 groups of acceleration and deceleration time, setting range 0.00s ~ 60000s
	DC bus voltage control	Overvoltage stall control: limit the power generation of the motor by adjusting the output frequency to avoid skipping the voltage fault; Undervoltage stall control: control the power consumption of the motor by adjusting the output frequency to avoid yaw failure VdcMax Control: Limit the amount of power generated by the motor by adjusting the output frequency to avoid over-voltage trip; VdcMin control: Control the power consumption of the motor by adjusting the output frequency, to avoid jump undervoltage fault
	Carrier frequency	1kHz~12kHz(Varies depending on the type)
	Startup method	Direct start (can be superimposed DC brake); speed tracking start
Stop method	Deceleration stop (can be superimposed DC braking); free to stop	
Maincontrol function	Jog control, droop control, up to 16-speed operation, dangerous speed avoidance, swing frequency operation, acceleration and deceleration time switching, VF separation, over excitation braking, process PID control, sleep and wake-up function, built-in simple PLC logic, virtual Input and output terminals, built-in delay unit, built-in comparison unit and logic unit, parameter backup and recovery, perfect fault record,fault reset, two groups of motor parametersfreewitching, software swap output wiring, terminals UP / DOWN	
Function	Keypad	LED Digital keyboard and LCD keypad(option)
	Communication	Standard: MODBUS communication CAN OPEN AND PROFINET(IN DEVELOPMENT)

	PG card	Incremental Encoder Interface Card (Differential Output and Open Collector), Rotary Card ,frequency division signal pg card
	Input terminal	Standard: 5 digital input terminals, one of which supports high-speed pulse input up to 50kHz; 2 analog input terminals, support 0 ~ 10V voltage input or 0 ~ 20mA current input; Option card: 4 digital input terminals 2 analog input terminals.support-10V-+10V voltage input
	Output terminal	standard: 1 digital output terminal; 1 high-speed pulse output terminal (open collector type), support 0 ~ 50kHz square wave signal output; 2 relay output terminal 2 analog output terminals, support 0 ~ 20mA current output or 0 ~ 10V voltage output; Option card: 4 digital output terminals
Protection	Refer to Chapter 6 "Troubleshooting and Countermeasures" for the protection function	
Environment	Installation location	Indoor, no direct sunlight, dust, corrosive gas, combustible gas, oil smoke, vapor, drip or salt.
	Altitude	0-3000m.inverter will be derated if altitude higher than1000m and rated output current will reduce by 1% if altitude increase by 100m
	Ambient temperature	-10°C~ +40°C,maximum 50°C (derated if the ambient temperature is between 40°C and 50°C)Rated output current decrease by 1.5% if temperature increase by 1°C
	Humidity	Less than 95%RH, without condensing
	Vibration	Less than 5.9 m/s ² (0.6 g)
	Storage temperature	-20°C ~ +60°C
Others	Installation	Wall-mounted, floor-controlled cabinet, transmural
	Protection level	IP20
	cooling method	Forced air cooling
EMC	CE ROHS	Internal EMC filter Complies with EN61800-3 Category C3 3 rd Environment

Chapter 3 Product appearance and Installation Dimension

3.1 Product appearance and installation

3.1.1 Product appearance

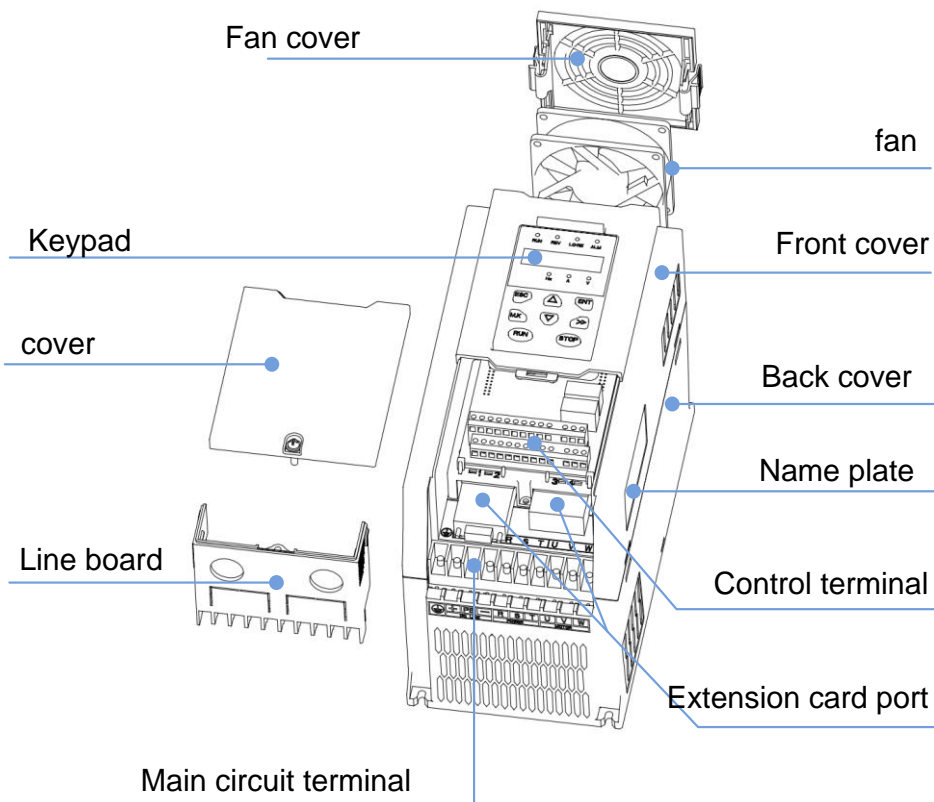

3-1-1 0.75kw-15kw

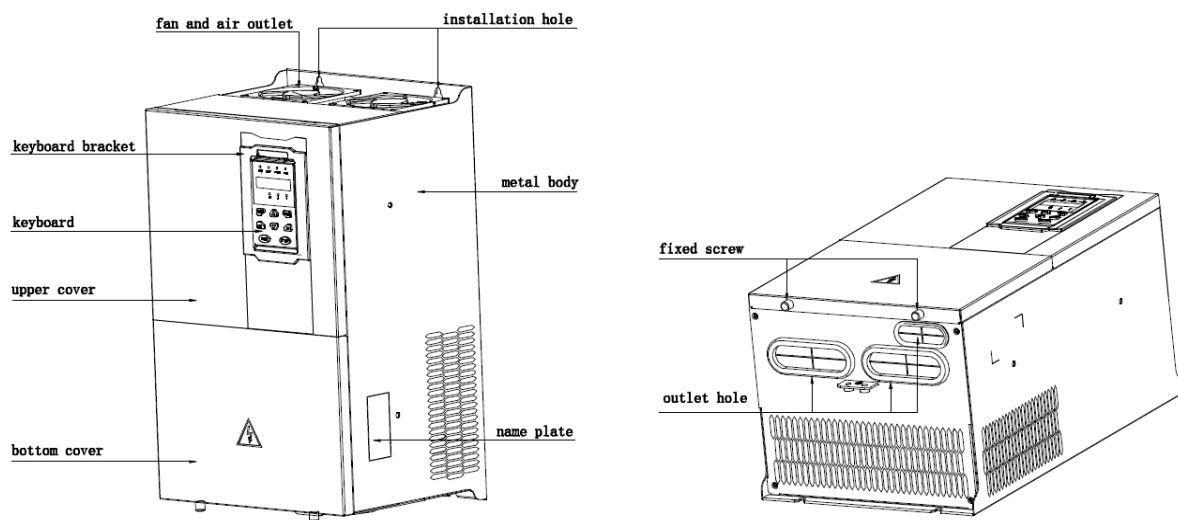

3-1-2 18.5kw-90kw

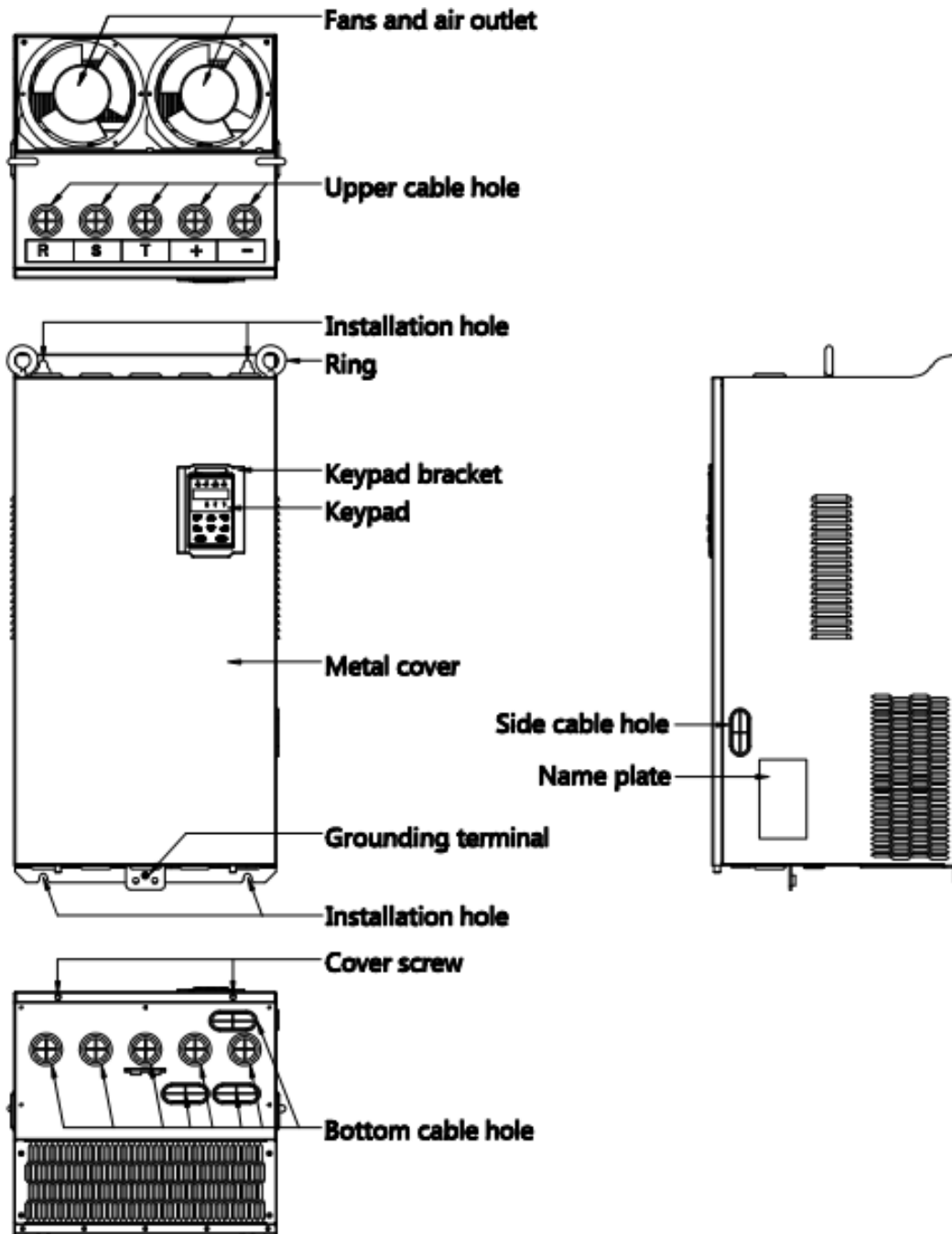

3-1-3 110kw-250kw

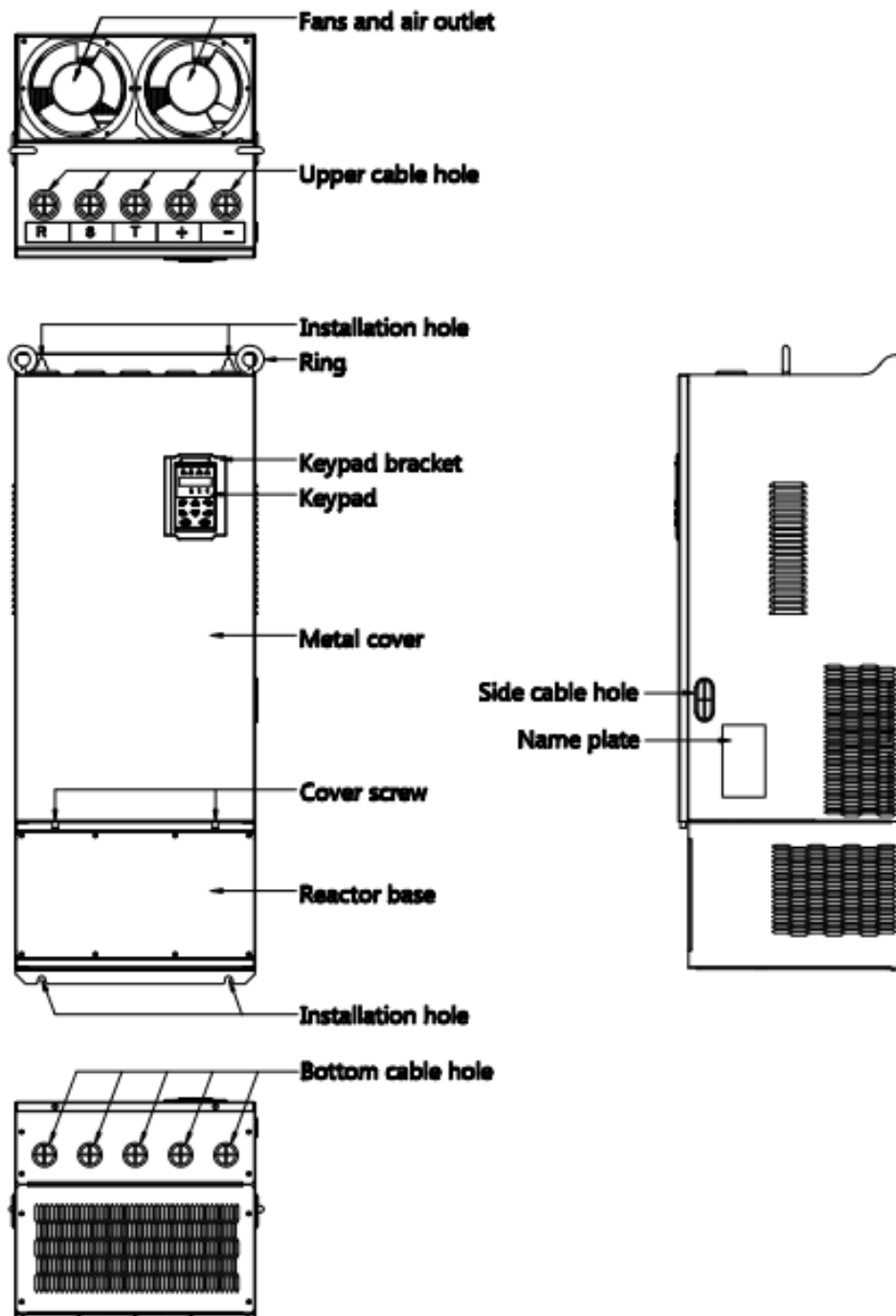

3-1-4 110KW-250KW (With bottom base)

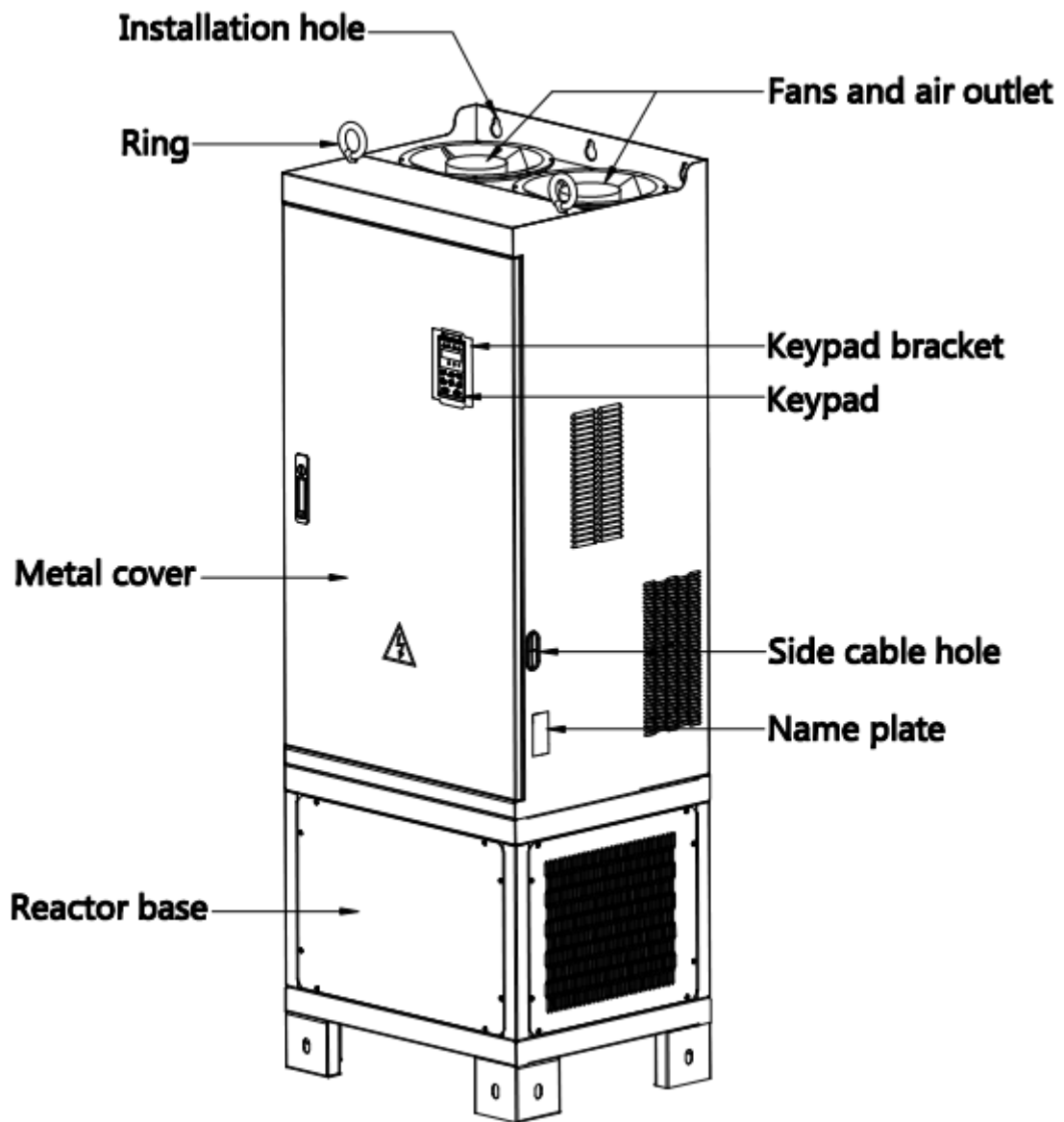

3-1-5 280KW-400KW

3.1.2 Appearance and Mounting Hole Dimension

◆ Keypay and keypad support size

The dimensions of the VFD530 series keypad are shown in Figure 3-1. When installing the keypad on the outside of the control cabinet, use the two screws on the back of the keypad to fix it (right side of Figure 3-1).

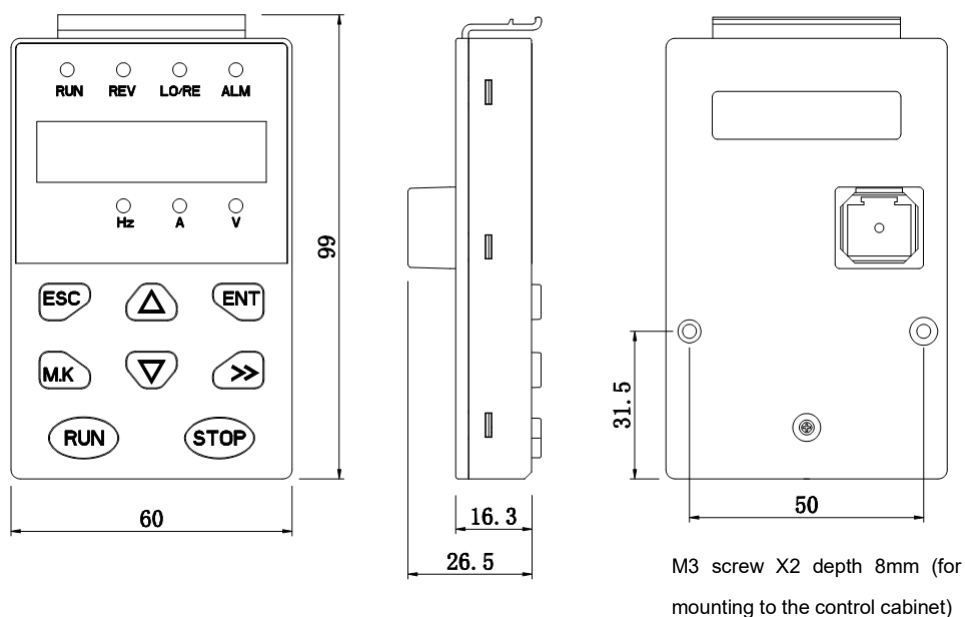

Diagram 3-2 Keypad dimension

If you want to mount keyboard on control cabinet (to prevent the keypad from protruding toward the outside of the control cabinet), use a keypad Bracket. The dimensions of the keypad bracket are shown in Figure 3-2. The dimensions of the mounting diagram and control cabinet are shown in Figure 3-3.

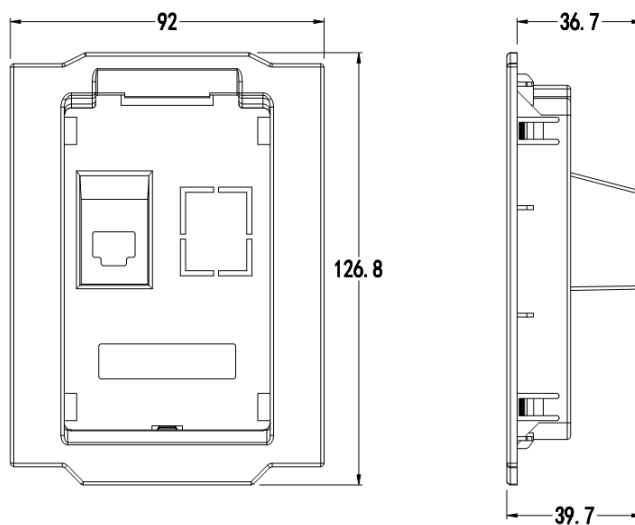

Figure 3-3 Keypad Holder Size (Unit: mm)

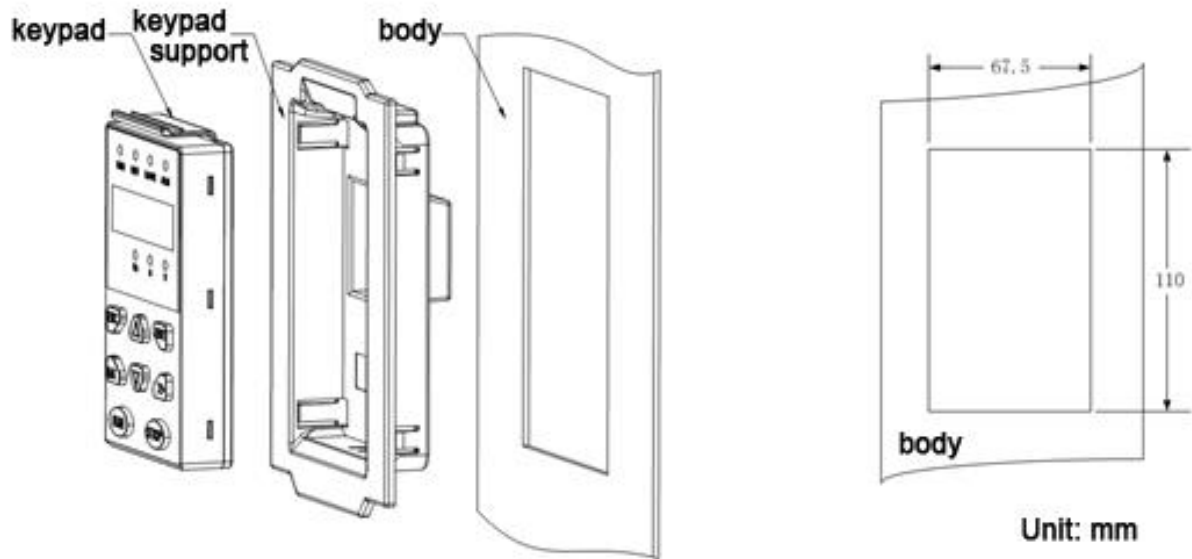

Figure 3-4 Keypad support installation diagram and control cabinet processing dimensions

◆ Inverter dimensions and installation dimensions

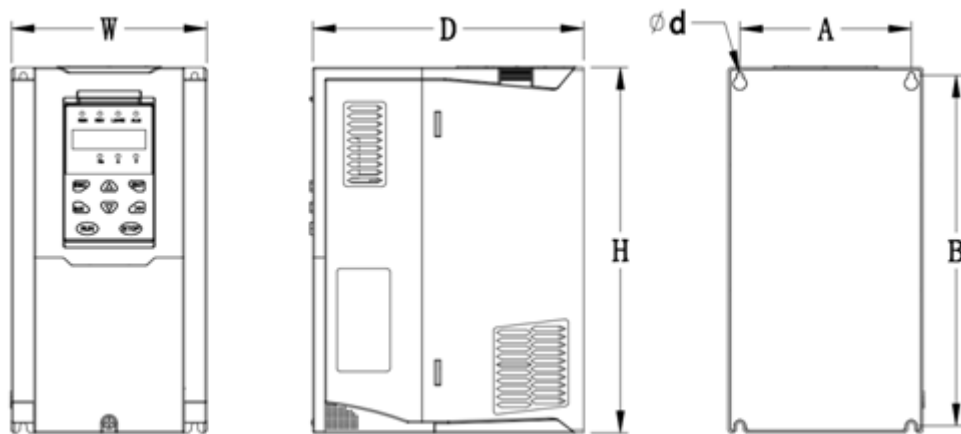

Figure 3-5 SIZE A to SIZE C(0.75KW-15KW) Dimension

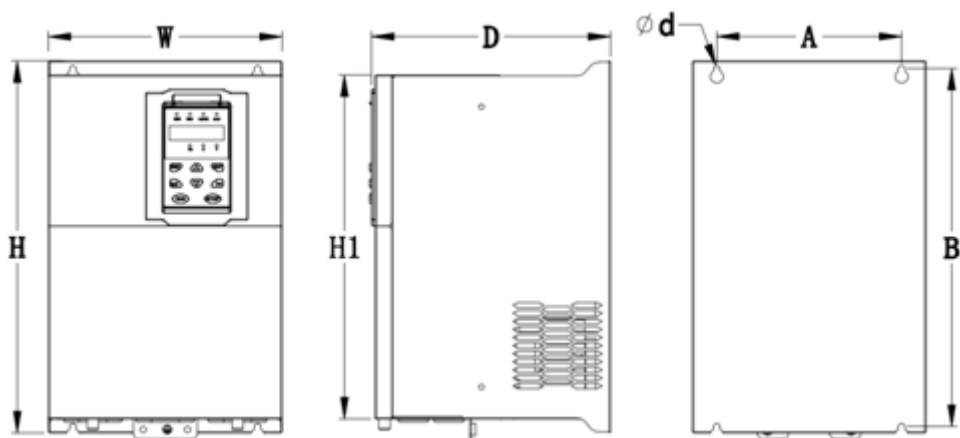

Figure 3-6 SIZE D~G(18.5KW-90KW) Dimension

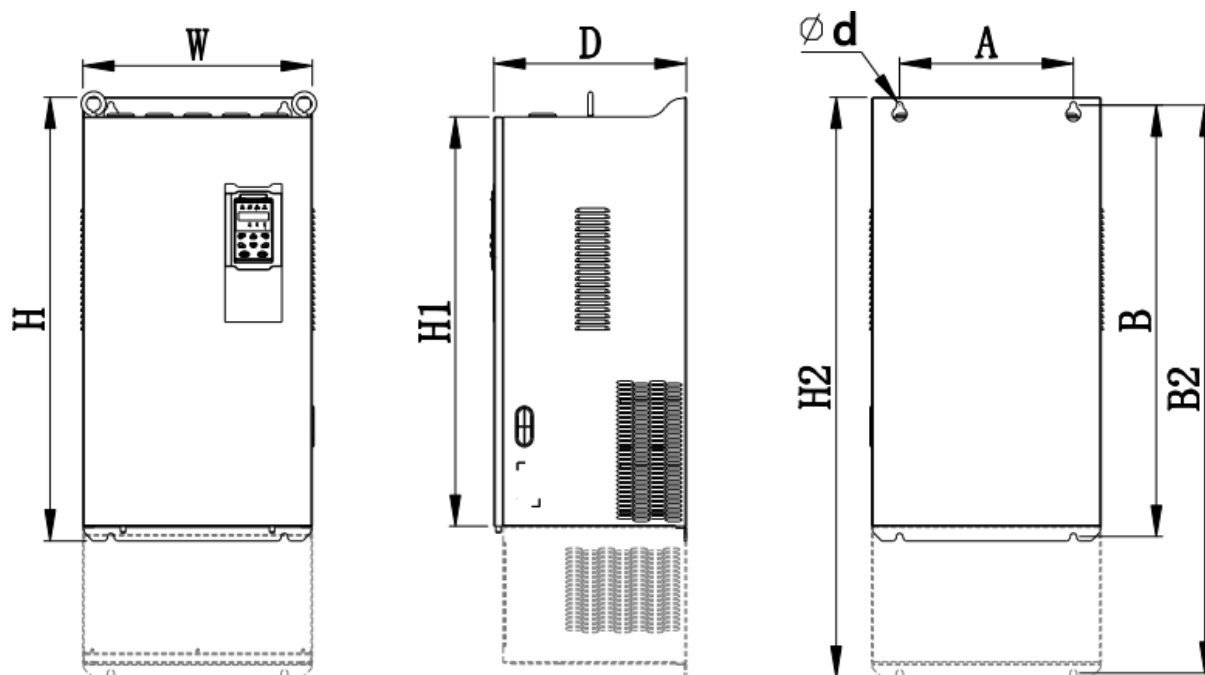

Figure 3-7 SIZE H~J(110KW-250KW) Dimension

Note: SIZE H~SIZE J (110kw-200kw) standard model without reactor and bottom base
 Reactor and bottom base for option

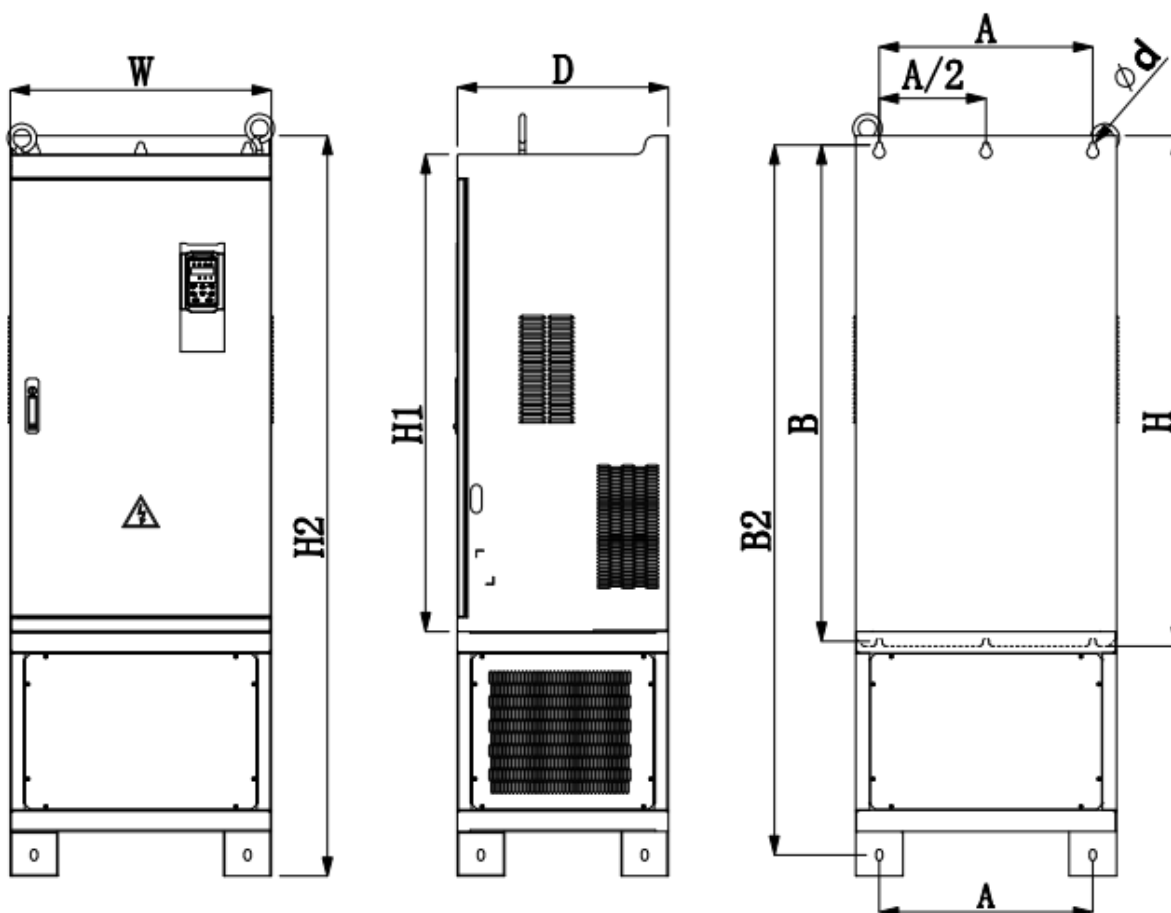

Figure 3-8 SIZE K~J(280KW-315KW) Dimension

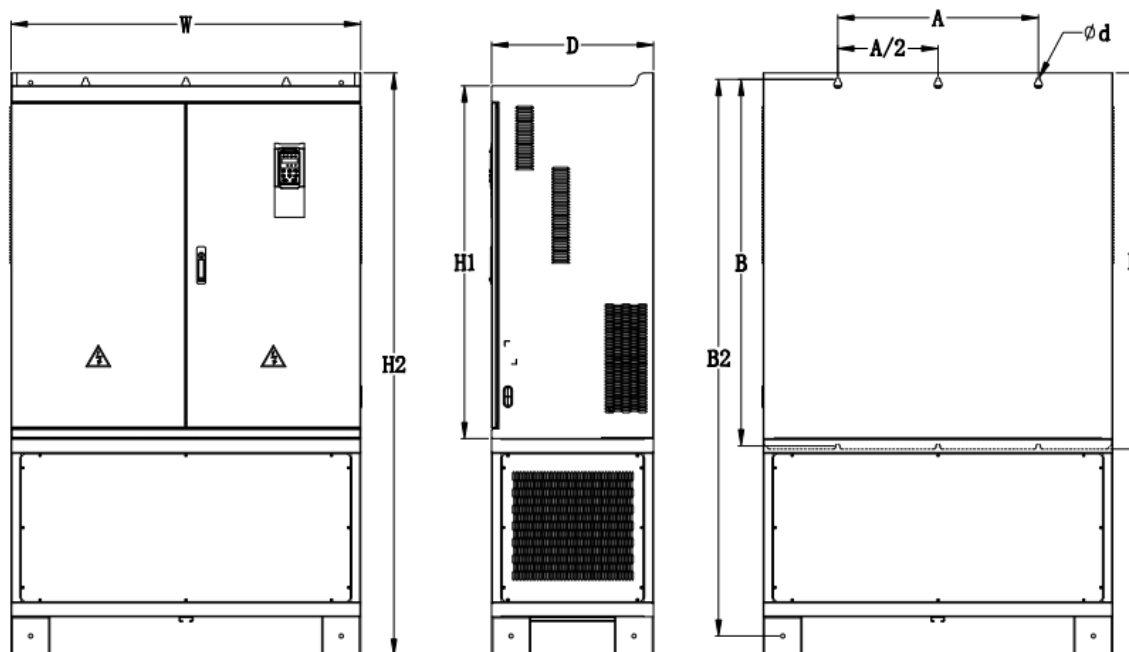

Figure 3-9 SIZE K~O(315KW-710KW) Dimensions

Table 3-1 VFD530 series appearance and installation dimension

SIZE	Appearance and installation dimension (mm)									
	A	B	B2	H	H1	H2	W	D	Φd	Mounting screws
0.75KW-4KW	87	206.5	/	215	/	/	100	170	ø5.0	M4X16
5.5KW-7.5KW	113	239.5	/	250	/	/	130	180	ø5.0	M4X16
11KW-15KW	153	299	/	310	/	/	170	193	ø6.0	M5X16
18.5KW-22KW	165	350	/	370	335	/	210	205	ø6.0	M5X16
30KW-37KW	218	438	/	452.5	424	/	260	230	ø7.0	M6X16
45KW-55KW	250	535	/	555	520	/	320	275	ø10.0	M8X20
75KW-90KW	280	620	/	640	605	/	350	290	ø10.0	M8X20
110KW	280	695	915	715	660	935	370	313	ø11.0	M8X25
132KW-160KW	280	705	925	725	670	945	360	338	ø11.0	M8X25
185KW-200KW	360	795	1145	816	762	1166	490	358	ø11.0	M10X25
220KW-250KW	360	795	1145	816	762	1166	490	358	ø11.0	M10X25
280KW-315KW	450	1045	1495	1075	1005	1560	550	450	ø13.0	M12X30
355KW-400KW	630	1013	1425	1045	970	1495	730	450	ø13	M12×30
450KW-500KW	660	1065	/	1575	1095	/	785	450	ø13	M12×30
560KW-710KW	620	1130	/	1800	1170	/	1080	500	ø13	M12×30

Remarks:

(1) B2 and H2 are the installation dimensions when the reactor base is included.

(2) Φd is the diameter of the installation screw hole of the whole machine.

3.1.3 Removal and installation of cover and inlet plate

◆ SIZEA~SIZE C (0.75KW-15KW) Removal and installation of cover and inlet plate:

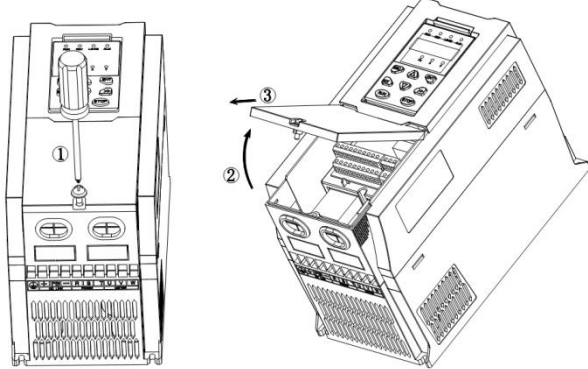
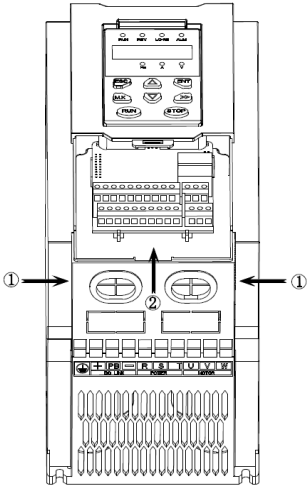
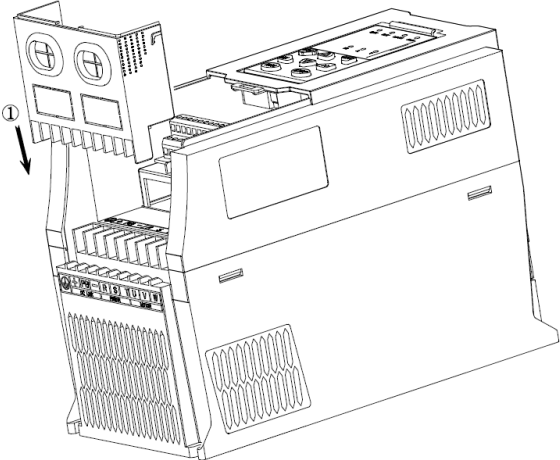
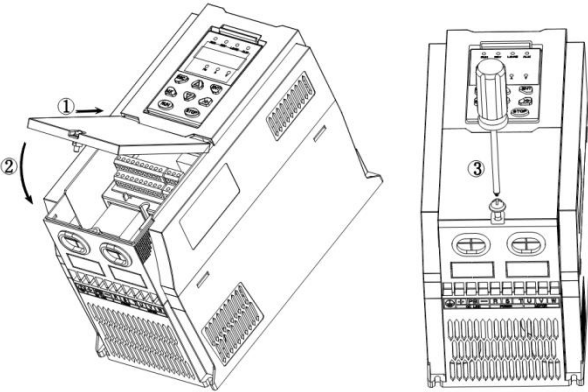
Removal steps	
 <p>Step 1: Open the top cover</p> <ol style="list-style-type: none"> ① Unscrew the screw on the cover ② Lift up the cover ③ Remove the cover from the front 	 <p>Step 2: Take out the inlet board</p> <ol style="list-style-type: none"> ① Hold down the sides of the inlet plate with your thumb and middle finger ② Press to disengage the buckle and pull it out of the board
Installation steps	
 <p>Step 1: Install the inlet board</p> <ol style="list-style-type: none"> ① Install the inlet board ② Put the inlet board from the top down into the mounting position to ensure that the card buckles 	 <p>Step 2: Install the upper cover</p> <ol style="list-style-type: none"> ① Slant the front cover diagonally from the front to the docking station ② Lower the cover plate toward the inlet board ③ Tighten the screws on the cover

◆ SIZE D-G(18.5KW-90KW) Removal and installation of cover:

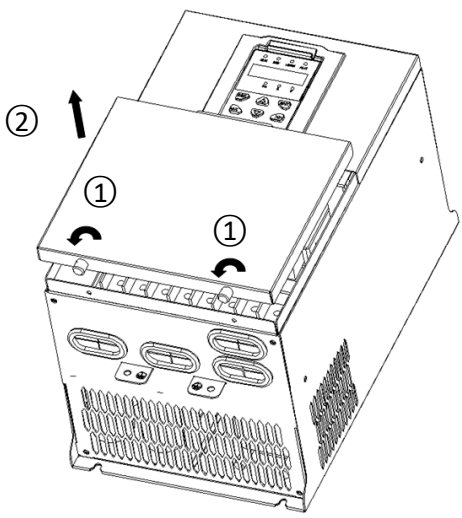
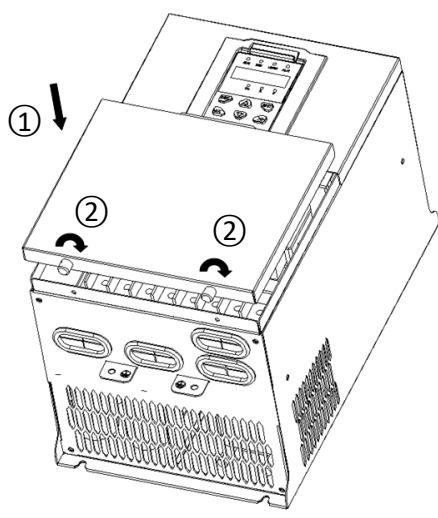
Removal steps	Installation steps
 <p>① Unscrew the two screws at the bottom of the bottom cover</p> <p>② Remove the cover vertically</p>	 <p>① Close the cover vertically</p> <p>② Tighten the two screws on the bottom of the cover</p>

◆ SIZEH~SIZE I(110KW-160KW) Removal and installation of cover

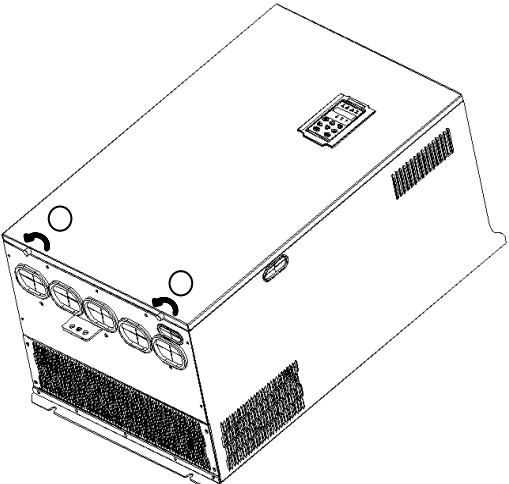
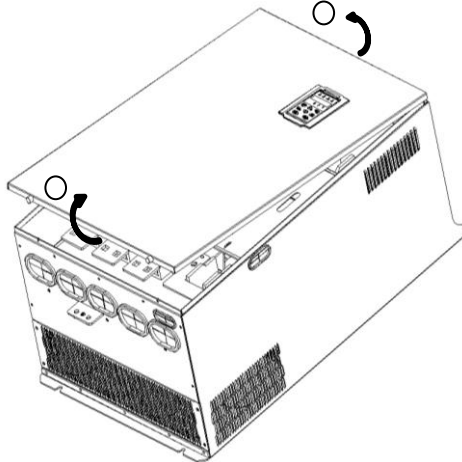
 <p>① Unscrew the two screws at the bottom of the cover</p>	 <p>② Hold both sides of the cover with both hands and lift the lower part of the cover</p> <p>③ Push up and lift the entire cover (be careful or you will snap the keyboard cable)</p>
<p>Installation steps</p>	

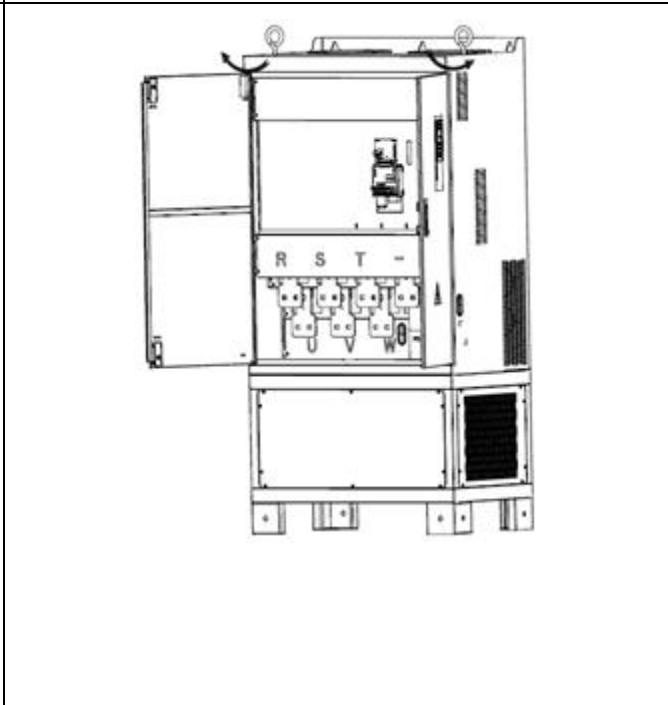
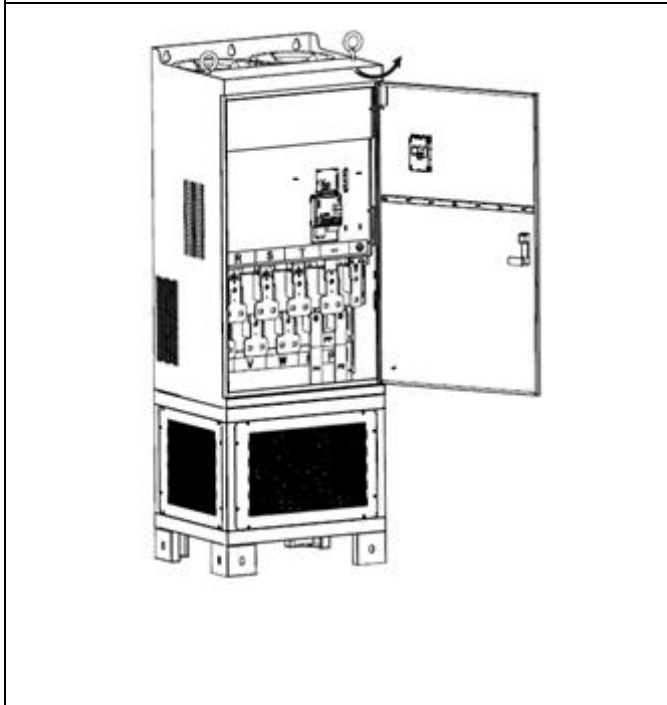
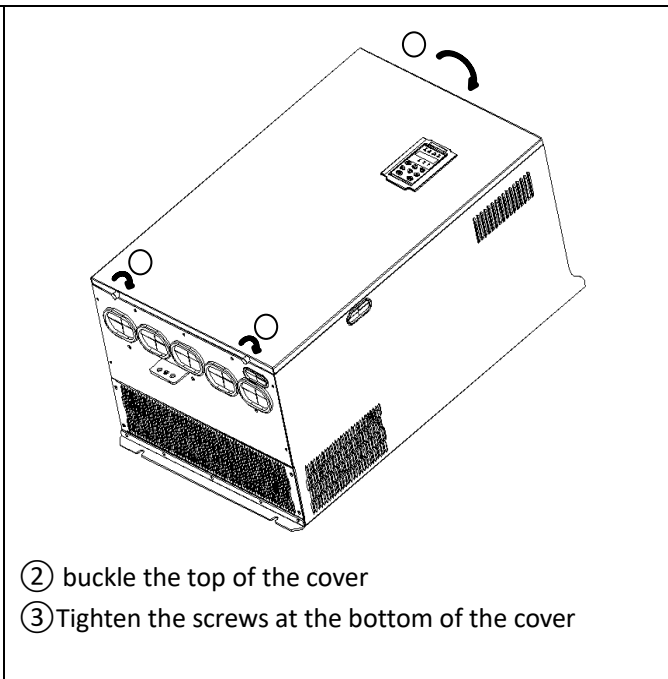
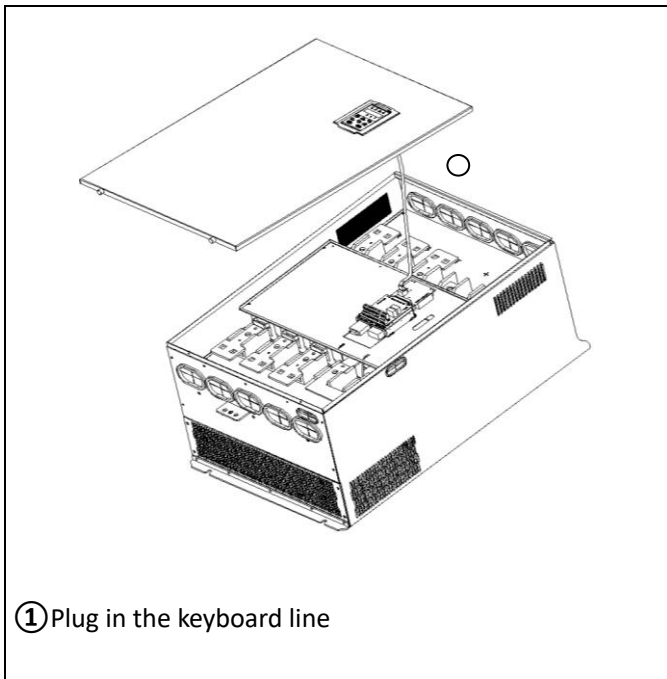

110kw and above are door-open style

3.2 Wiring

3.2.1 Standard wiring diagram

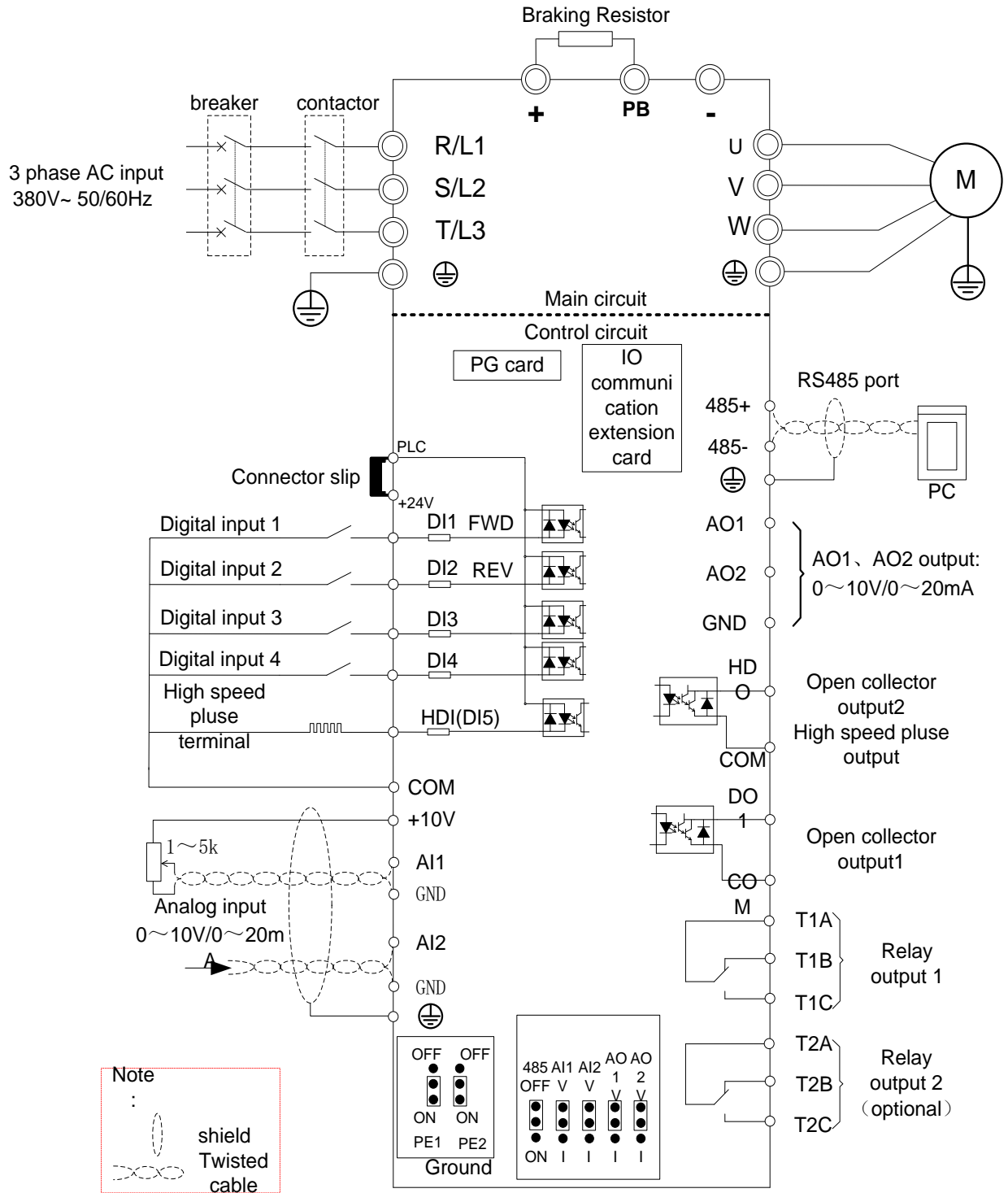

Diagram 3-10 standard wiring

3.2.2 Main Circuit Terminals

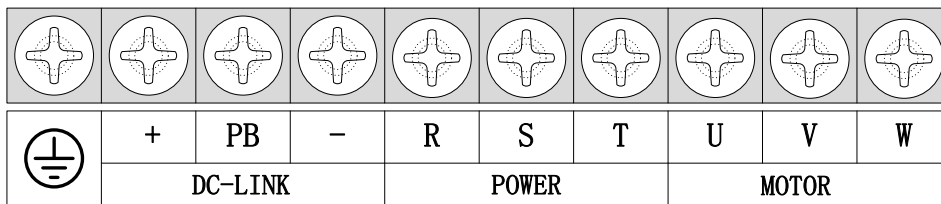

Figure 3-11 SIZE A~SIZE C(0.75kw-15kw) Main Circuit Terminal

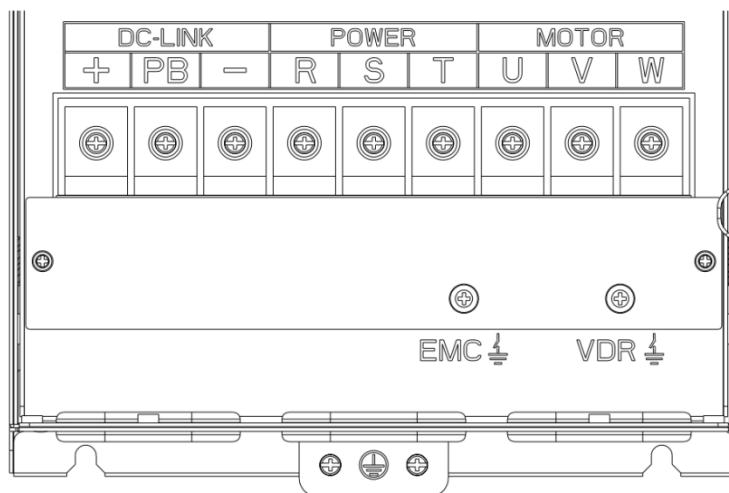

Figure 3-12 SIZE D 18.5kw-22kw main circuit terminal block diagram

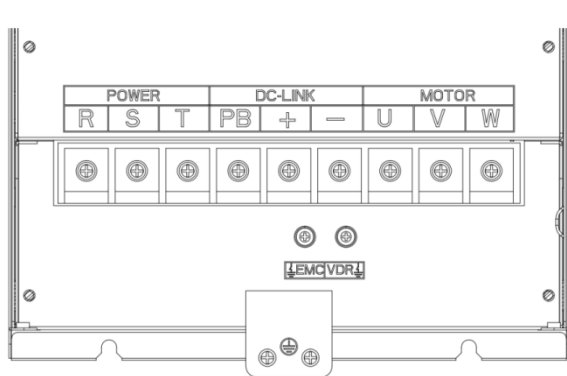

Figure 3-13 SIZE E 30kw-37kw (LEFT)

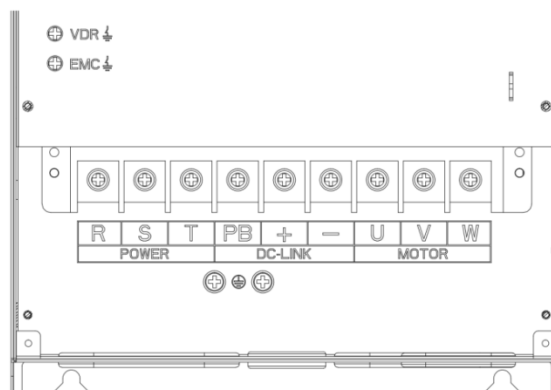

Figure 3-14 SIZE F~G45kw-90kw(RIGHT)

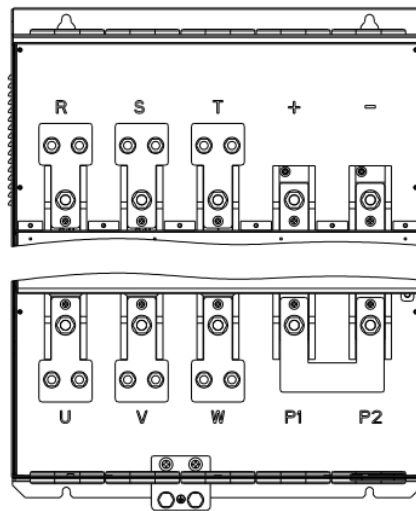

Figure 3-15 110kw-250kw Main Circuit Terminal Blocks

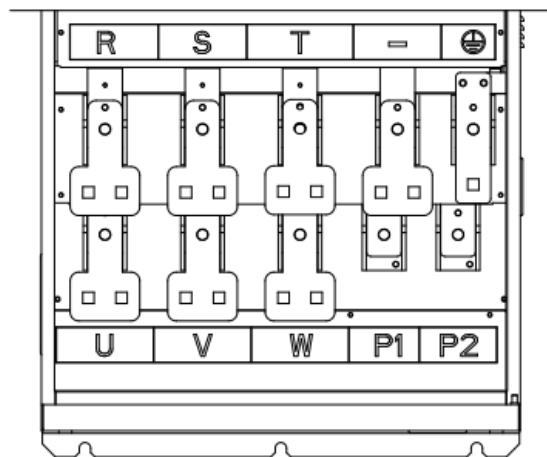

Figure 3-16 280kw-400kw Main Circuit Terminal Blocks

Table 3-17 Function description of the main circuit terminal of the inverter

Terminal	Function instruction
R、S、T	AC power input terminal, connect three-phase AC power
U、V、W	Inverter AC output terminal, connect three-phase AC motor
+、-	The positive and negative terminals of the internal DC bus are connected to the external brake unit or For common DC bus
P1、P2	P1 and P2 are terminal to Connect DC reactor, short P1 to P2 when DC reactor is not used (P2 is equivalent to "+" of DC bus)
+、PB	Braking resistor connection terminal when built-in brake unit
⊕	Ground terminal, ground
EMC、VDR	Safety capacitor and varistor grounding selection screw (SIZE A~SIZE C EMC screw on the left side of the fuselage)

3.2.3 Terminal screws and wiring specifications

Table 3-18 Main circuit cable and screw specifications

Model number	Power terminal			Ground terminal		
	Screw	Tightening torque (N·m)	Cable diameter (mm ²)	screw	Tightening torque (N·m)	Cable diameter (mm ²)
VFD530-R75GT4B	M3	1.5	2.5	M3	1.5	2.5
VFD530-1R5GT4B	M3	1.5	2.5	M3	1.5	2.5
VFD530-2R2GT4B	M3	1.5	2.5	M3	1.5	2.5
VFD530-4R0G/5R5PT4B	M3	1.5	4	M3	1.5	4
VFD530-5R5G/7R5PT4B	M4	2	6	M4	2	6
VFD530-7R5G/011PT4B	M4	2	6	M4	2	6
VFD530-011G/015PT4B	M5	4	10	M5	4	10
VFD530-015G/018PT4B	M5	4	10	M5	4	10
VFD530-018G/022PT4B	M6	4	10	M6	4	10
VFD530-022G/030PT4B	M6	4	16	M6	4	16
VFD530-030G/037PT4	M8	10	16	M6	5	10
VFD530-037G/045PT4	M8	10	16	M6	5	10
VFD530-045G/055PT4	M8	10	25	M6	5	16
VFD530-055G/075PT4	M8	10	35	M6	5	16
VFD530-075G/090PT4	M10	20	50	M8	8	25
VFD530-090G/110PT4	M10	20	70	M8	8	35
VFD530-110G/132PT4	M10	20	120	M8	10	70
VFD530-132G/160PT4	M12	35	150	M8	10	70
VFD530-160G/185PT4	M12	35	185	M8	10	70
VFD530-185G/200PT4	M12	35	95*2	M10	15	95
VFD530-200G/220PT4	M12	35	95*2	M10	15	95
VFD530-220G/250PT4	M12	35	120*2	M10	15	120
VFD530-250G/280PT4	M12	35	120*2	M10	15	120
VFD530-280G/315PT4	M12	35	150×2	M12	15	120
VFD530-315G/355PT4	M12	35	150×2	M12	15	150
VFD530-355G/400PT4	M12	35	150×2	M12	15	150
VFD530-400G/450PT4	M12	35	185×2	M12	15	185
VFD530-450G/500PT4	M12	35	240×2	M12	15	240
VFD530-500G/560PT4	M12	35	240×2	M12	15	240
VFD530-560G/630PT4	M12	35	185×3	M12	15	185
VFD530-630GT4	M12	35	240×3	M12	15	240
VFD530-710GT4	M12	35	240×3	M12	15	240

3.2.4 Cautions for Main Circuit Wiring

(1) Power Supply Wiring

- ◆ It is forbidden to connect the power cable to the output terminal of the inverter. Otherwise, the internal components of the inverter will be damaged.
- ◆ In order to provide input side overcurrent protection and power outage overhaul convenience, the inverter should be connected to the power supply through circuit breakers and contactors.
- ◆ Please confirm the power phase, the voltage is consistent with the product nameplate, do not match may result in damage to the inverter.

(2) DC wiring

- ◆ Do not connect the braking resistor directly to +, -, which may cause the inverter to be damaged or even fire.
- ◆ When using the external brake unit, pay attention to +, - can not be reversed, otherwise it will cause damage to the inverter and brake unit or even cause a fire.

(3) Motor Wiring

- ◆ It is forbidden to short circuit or ground the inverter output terminal, otherwise the internal components of the inverter will be damaged.
- ◆ Avoid short circuit the output cables or with the inverter enclosure, otherwise there exists the danger of electric shock.
- ◆ It is forbidden to connect the output terminal of the inverter to the capacitor or LC/RC noise filter with phase lead, otherwise, the internal components of the inverter may be damaged.
- ◆ When contactor is installed between the inverter and the motor, it is forbidden to switch on/off the contactor during the running of the inverter, otherwise, there will be large current flowing into the inverter, triggering the inverter protection action.
- ◆ Length of cable between the inverter and motor
If the cable between the inverter and the motor is too long, the higher harmonic leakage current of the output end will produce by adverse impact on the inverter and the peripheral devices. It is suggested that when the motor cable is longer than 100m, output AC reactor be installed. Refer to the following table for the carrier frequency setting.

3.2.5 Control Circuit Terminal

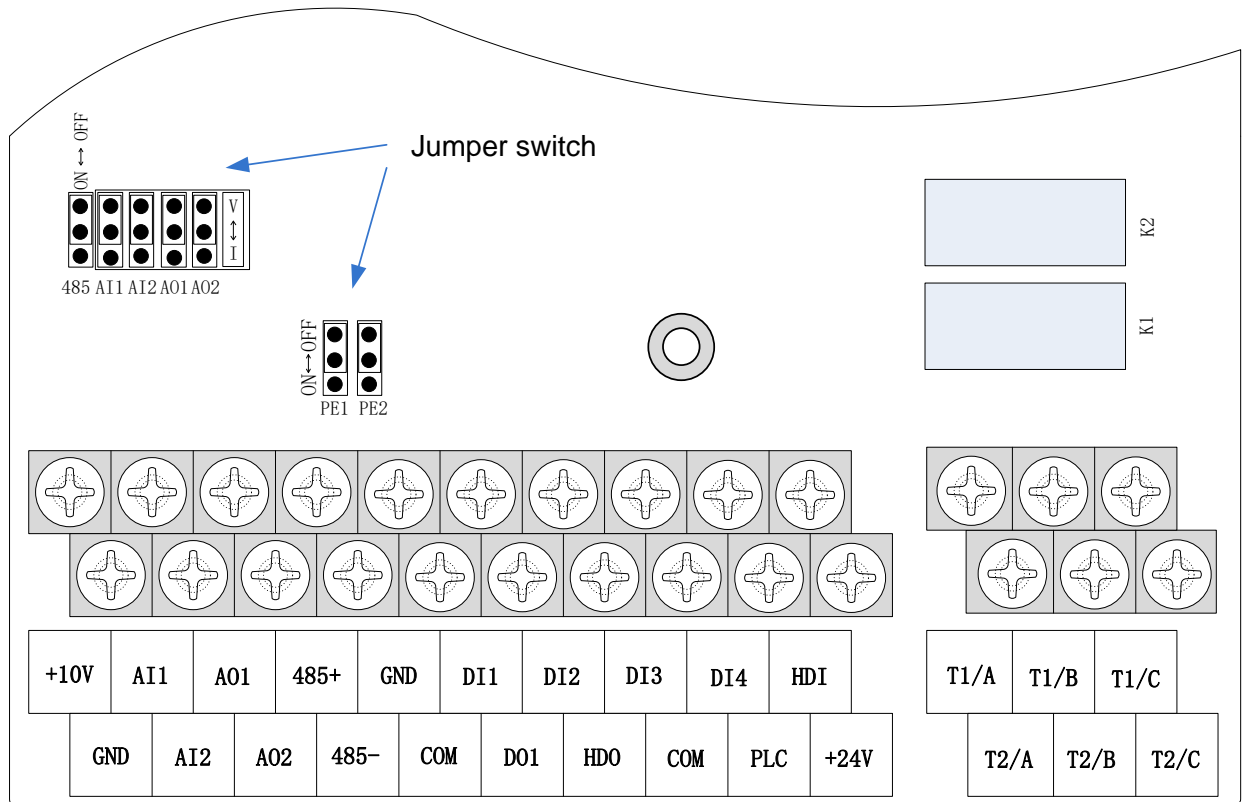

Diagram 3-19 VFD530 control circuit terminal

Table 3-20 VFD530 control circuit terminal instruction

Type	Terminal Symbol	Terminal Name	Terminal function description
Analog input voltage	+10V	Input voltage	10.10V±1%
			Maximum output current:10mA, it provides power supply to external potentiometer with resistance range of: 1KΩ~51KΩ
	GND	Analog ground	Internal isolation from COM
	AI1	Analog input1	Input voltage:0~10V: Impedance 22KΩ, Maximum input voltage
			Input current:0~20mA: Impedance 500Ω, Maximum input current
			Through the jumper switch AI1 0 ~ 10V and 0 ~ 20mA analog input switch, the factory default voltage input.
	AI2	Analog input 2	Input voltage:0~10V: Impedance 22KΩ, Maximum input voltage
			Input current:0~20mA: Impedance 500Ω, Maximum input current
Through the jumper switch AI1 0 ~ 10V and 0 ~ 20mA analog input switch, the factory default voltage input.			
Analog output	AO1	Analog output 1	Output voltage:0~10V: Impedance ≥10KΩ
			Output current:0~20mA: Impedance 200Ω~500Ω
			Through the jumper switch AO1 0 ~ 10V and 0 ~ 20mA analog output switching, the factory default voltage output.
	AO2	Analog output 2	Output voltage:0~10V: Impedance ≥10KΩ
			Output current:0~20mA: Impedance 200Ω~500Ω
			Through the jumper switch AO1 0 ~ 10V and 0 ~ 20mA analog output switching, the factory default voltage output.
GND	Analog ground	Internal isolation from COM	
Switch input	+24V	+24V current	24V±10%, Internal isolation from GND
			Maximum output current: 200mA
			To provide 24V power supply, generally used as a digital input and output terminal power supply and external sensor power
	PLC	Digital input terminal common	The factory default setting is connected PLC with +24V
			Terminal for on-off input high and low level switch
	COM	+24V ground	When using the external signal to drive DI1~DI5, it will disconnect the connector slip of PLC with the +24V
			Internal isolation from GND
	DI1~DI4	Digital input terminal 1~4	Optocoupler isolation, compatible with bipolar input
Frequency range: 0~200Hz			
HDI	Digital input	Voltage range: 10V~30V	
		Digital input terminal: same as DI1~DI4	

Type	Terminal Symbol	Terminal Name	Terminal function description
		terminal /High-speed pulse input	Pulse input frequency input: 0~50KHz Voltage range: 10V~30V
Switch output	DO1	Open collector output	Optocoupler isolation Voltage range: 0V~24V Current range: 0mA ~50mA
	HDO	Open collector output /High-speed pulse output	Open collector output: same as DO1 High-speed pulse output: 0~50KHz
Relay output 1	T1A/T1B/T1C	Relay output	T1A-T1B: normal close
			T1A-T1C: normal open
			Contact rating: AC 250V, 3A; DC 30V, 1A
Relay output2 (optional)	T2A/T2B/T2C	Relay output	T2A-T2B: normal close
			T2A-T2C: normal open
			Contact rating: AC 250V, 3A; DC 30V, 1A
485 port	485+	485 Positive differential signal	Baud rate: 1200/2400/4800/9600/19200/38400/57600/115200bps
	485-	485 Negative differential signal	

Table 3-21 Functional Description of VFD530 Jumper Switch

Name	Function	Defaults
485	485 Termination resistor selection: ON has 100 ohm terminating resistor, OFF is no terminating resistor	OFF
AI1	AI1 analog type selection: V is the voltage input (0 ~ 10V), I is the current input (0 ~ 20mA)	V
AI2	AI2 analog type selection: V is the voltage input (0 ~ 10V), I is the current input (0 ~ 20mA)	V
AO1	AO1 analog type selection: V is the voltage output (0 ~ 10V), I is the current output (0 ~ 20mA)	V
AO2	AO2 analog type selection: V is the voltage output (0 ~ 10V), I is the current output (0 ~ 20mA)	V
PE1	GND ground selection: ON is grounded through the safety capacitor, OFF is not connected	OFF
PE2	COM ground selection: ON is grounded through the safety capacitor, OFF is not connected	OFF

◆ Analog input terminal instructions

The AI1 and AI2 terminals can accept both analog voltage input and analog current input. They can be switched by jumpers "AI1" and "AI2" on the IO board. The connection method and jumper

switch configuration are shown in the following figure:

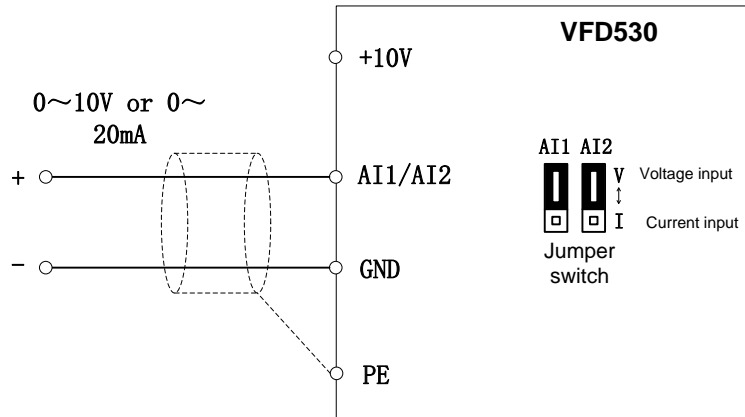

Figure 3-22 Analog input terminal wiring diagram

The AO1 and AO2 terminals support the voltage output (0~10V) and the current output (0~20mA). They are selected by jumpers “AO1” and “AO2” on the IO board. The connection method is as shown in the figure below:

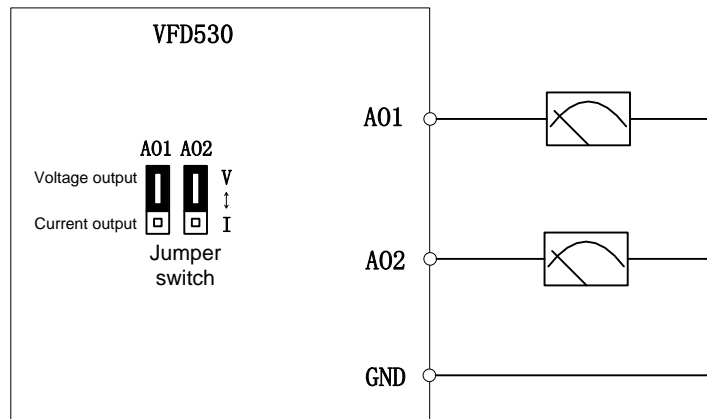
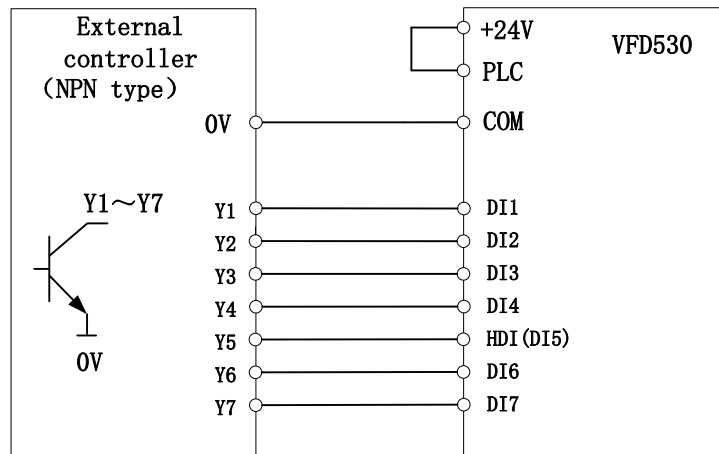
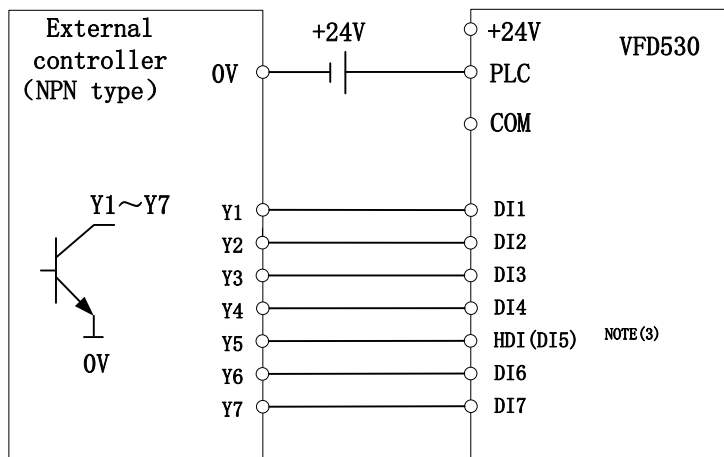

Figure 3-23 Analog output terminal wiring diagram

◆ Digital input terminal instructions





A: By internal 24V with NPN mode

B: By internal 24V with PNP mode

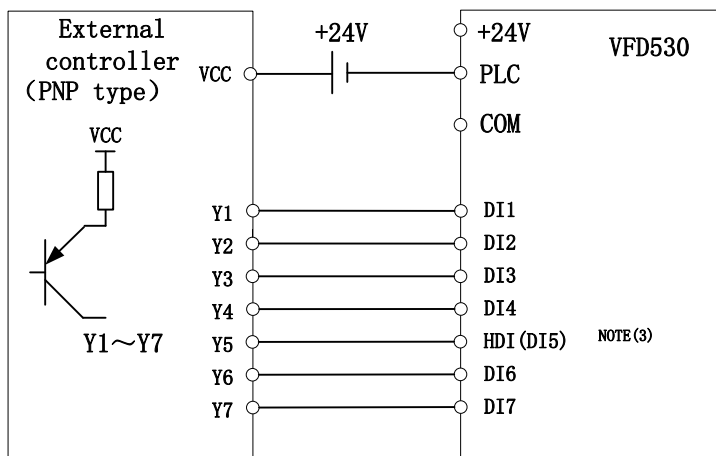
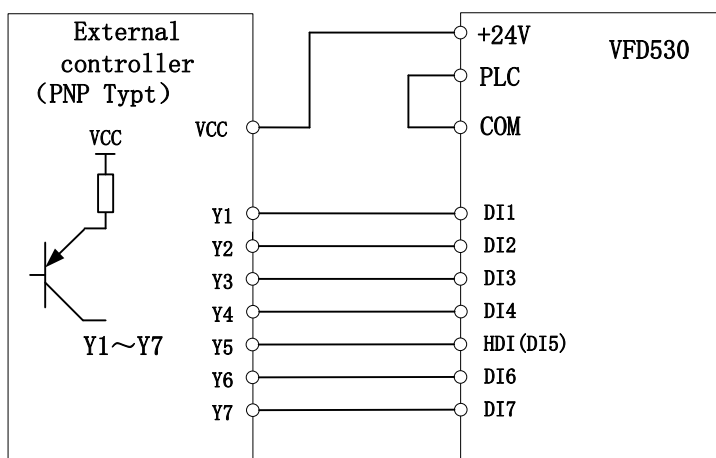

C: NPN mode uses external +24V power supply D: PNP mode uses external +24V power supply

3-24 Switching Digital input terminal wiring diagram

Note:

1. If the output of the external controller is a relay contact, it can be regarded as an NPN or PNP type. The "0V" or "VCC" of the external controller in the above figure can be regarded as the common terminal of the relay.
2. When using an external power supply, the shorting link between +24V and PLC must be removed, otherwise the product will be damaged!
3. When using an external power supply, when using HDI, connect the negative pole of the external power supply to COM, otherwise HDI will be invalid!
4. The voltage range of VCC is 10V~30V.

◆ Switch output terminal instructions

The multi-function output terminals DO1 and HDO can be powered by the internal +24V power supply of the inverter or an external power supply. The wiring diagram is as follows:

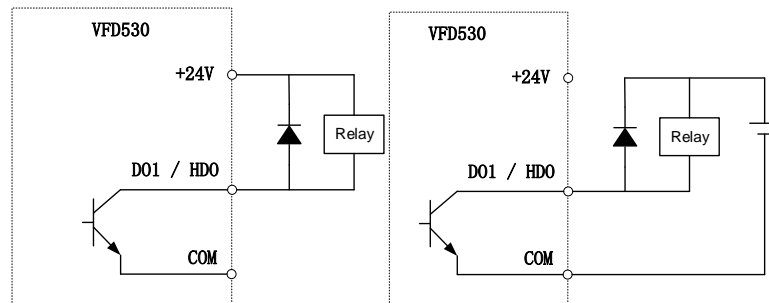

A、 Use internal power supply

B、 Use external power supply

3-25 Switching digital output terminal wiring diagram

Note:

The multi-function terminal output is an open collector output with a maximum allowable current of 50mA. When using the internal power supply, if the inductive load is driven, an absorption circuit such as an RC snubber circuit or a freewheeling diode should be installed. When adding a freewheeling diode, be sure to confirm the polarity of the diode, otherwise the product will be damaged. For external power supply, connect the negative terminal of the external power supply to the COM terminal.

◆ 485Communication terminal instructions

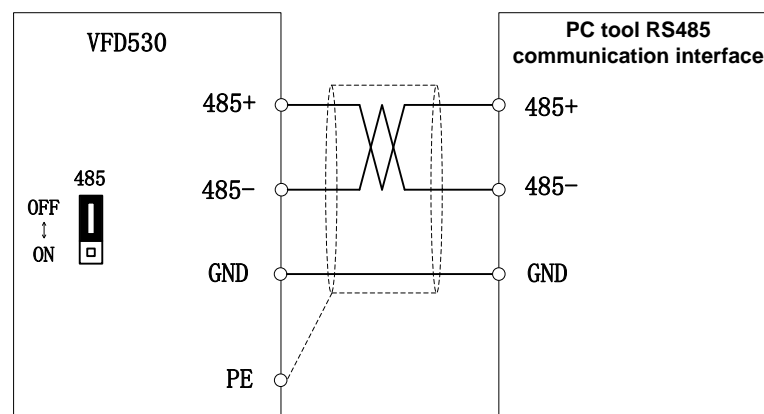

3-26 Single inverter RS485 directly communicates with the host computer

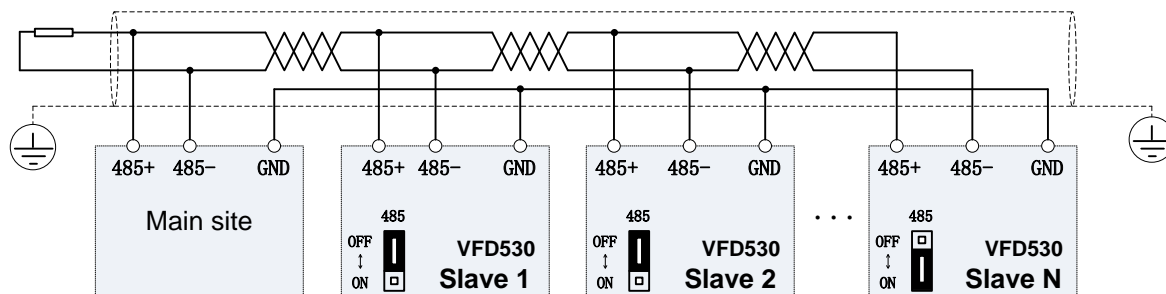

3-16 Multiple inverter RS485 is connected to the host computer for communication

3.3 EMC question and solution

The working principle of the inverter determines that it will certainly produce electromagnetic interference, affecting and interfering with other equipment. In the meantime, the frequency converter usually works under the industrial environment with very strong noise, its internal weak signal is also easily disturbed. For safe and trouble-free operation of the frequency converter, as well as the normal and orderly operation of other equipment, install the equipment according to the following rules.

- Install the input noise filter, the filter to the inverter input power supply side of the wiring should be as short as possible.
- Filter shell and the installation of the cabinet should be a large area of reliable connection, in order to reduce the noise current loop impedance.
- The wiring distance between inverter and motor should be as short as possible. The motor cable adopts 4-core cable. One end of the ground wire is grounded at the inverter side and the other end is connected with the motor case. The motor cable is sheathed into the metal pipe.
- Input power line and output motor line should be far away from each other.
- Easily affected equipment and signal lines should be installed away from the inverter.
- The key signal cable should use shielded cable. It is suggested that the shielded cable layer should be grounded by 360 degree grounding method and set in the metal pipe. As far as possible from the inverter input power cable and output motor cable, if the signal cable must cross the input power cable or output motor cable, the two should be orthogonal.
- When using the analog voltage and current signals for remote frequency setting, double-stranded, shielded and shielded cables should be used, and the shield should be connected to the grounding terminal PE of the inverter. The longest signal cable should not exceed 50 meters.
- The control circuit terminals T1A / T1B / T1C, T2A / T2B / T2C and other control circuit terminals should be separated wiring.
- It is forbidden to short-circuit the shield with other signal lines and equipment.
- When connecting the inductive load device (magnetic contactor, relay, solenoid valve, etc.) to the inverter, be sure to use the surge suppressor on the load device coil.
- Correct and reliable grounding is safe and reliable operation of the foundation:

(1) Inverter will generate leakage current, the greater the carrier frequency, the greater the leakage current. Inverter leakage current greater than 3.5mA, the size of the leakage current by the conditions of use, in order to ensure safety, inverter and motor must be grounded;

(2) Grounding resistance should be less than 10 ohms. Grounding cable diameter requirement, refer to the same type of input and output cables half of the cross-sectional area selection;

(3) Do not share the ground wire with welding machines and other power equipment;

(4) When using more than two inverters, do not make the ground wire loop.

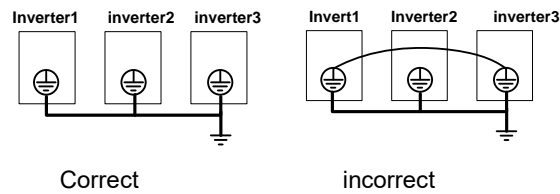

3-27-1 Ground wire connection diagram

- Frequency converter to motor cable length and carrier frequency to maintain the appropriate relationship

When the cable between the inverter and the motor is long, due to the influence of distributed capacitance, it is easy to produce electrical resonance, thus generating a large current so that the inverter over-current protection. It is recommended to install the AC output reactor when the motor cable length exceeds 100 meters. Refer to the following table for carrier frequency setting

Inverter output cable length and carrier frequency table

3-27-2 diagram

Cable length between drive and motor	20m below	50m below	100m below	100m above
Carrier frequency (P22.00)	15kHz below	8kHz below	4kHz below	2kHz below

Chapter 4 Operation and display

4.1 LED Instruction of operation and display









LED keyboard consists of 5 digital tubes, 7 lights, 8 keys and a potentiometer; can be used to set the parameters, status monitoring and operation control, LED keyboard shape as shown in Figure 4-1:



Figure 4-1 Operating panel

Description of indicator

Table 4-1 The name and function of each part of the keyboard

No.	Part	Name	Function
1		Exit	<ul style="list-style-type: none"> • exit menu level
2		Confirmation	<ul style="list-style-type: none"> • Enter the menu interfaces level by level, • confirm the parameter setting and save to EEPROM
3		Increment/Up	<ul style="list-style-type: none"> • The number indicated by the cursor increases by one. • Next function code. • Used to switch the left and right screens while in monitor mode
4		Decrement/Down	<ul style="list-style-type: none"> • The number indicated by the cursor minus one. • The previous function code.
5		Multi-function	<ul style="list-style-type: none"> • Perform function switchover according to the setting of 21.02
6		Shift	<ul style="list-style-type: none"> • Cursor shift. • Monitor Status Displays the next monitor volume. • Switch left and right screens.
7		Run	Start the frequency inverter in the operation panel control mode
8		Stop/Reset	<ul style="list-style-type: none"> • During operation, press to stop the operation (restricted by parameter 21.03). • In fault status, press this key to reset the fault.

9		Indicator light:Hz	· Indicate the digital display unit, all three lights off means other units
10		Indicator light:A	
11		Indicator light:V	
12		Indicator light:Hz+A(rpm/minute)	When Hz" and "A" are lit at the same time, the unit of the currently displayed parameter is "RPM PER MINUTE"
13		Indicator light:A+V(%)	When "A" and "V" are lit at the same time, the unit of the currently displayed parameter is "percent".
14		Running lights	<ul style="list-style-type: none"> • Off: indicates a stop condition. • On: indicates inverter is running. Blinking: Deceleration stopped.
15		Direction indicator	<ul style="list-style-type: none"> • Used to indicate the sign of the variable when the LED is displaying one of the variables listed in 27.02; • In other cases the sign of the output frequency is indicated.
16		Command source indicator	<ul style="list-style-type: none"> • Off: The command source is the keyboard. • On: The command source is terminal. • Blinking: The command source is communication.
17		Fault indicator	<ul style="list-style-type: none"> • When it is on, the drive is faulty.

4.2 Display hierarchy and menu mode

VFD530 digital keyboard display is divided into four layers, from top to bottom are: monitoring status, menu mode selection status, function code selection status, parameter editing / viewing status, as shown in Figure 4-2. In the menu mode selection status, press **【UP】** or **【DOWN】** key to select menu mode, press **【ENTER】** to enter the selected menu mode, the following describes several menu modes:

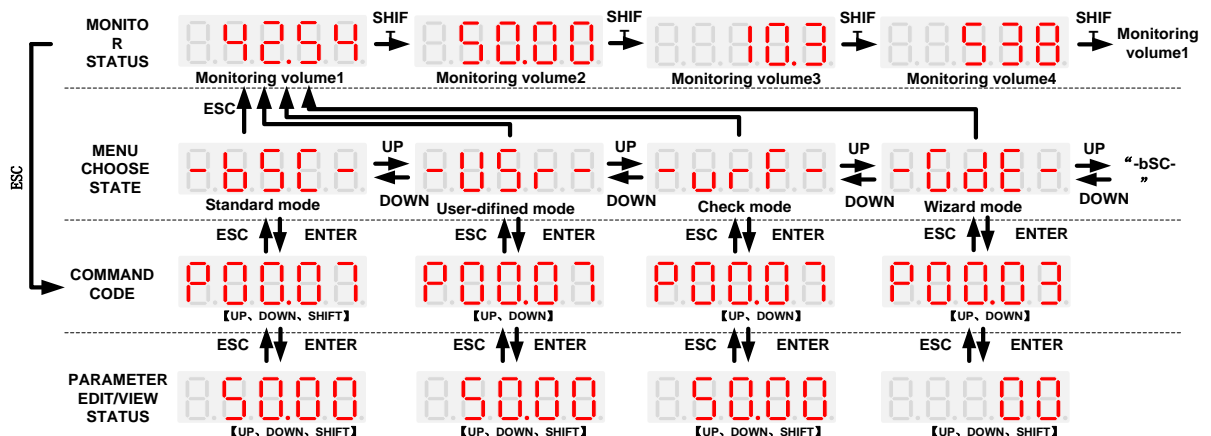

4-2Keyboard operation diagram

◆ Standard mode (-bSC-)

If visiting access (r00.01) is standard, all the function codes mentioned in this manual are accessible.

If visiting access (r00.01) is the end user (in the state of user password lock), then only some function code can be accessed.

◆ User-defined mode (-USr-)

In this menu mode, only 20 user-defined parameters defined are displayed.

◆ Verify mode (-vrF-)

In this menu mode, only parameters that differ from the factory settings are displayed.

◆ Guide mode (-GdE-)

When users first use the inverter, can guide the user to complete a simple trial run.

4.3 Digital tube display

Display of decimal data

16 digits:

The range of unsigned numbers is 0 ~ 65535 (without decimal point). The displayed range of signed numbers is -9999 ~ 32767 (excluding decimal point). The negative numbers less than -9999 will be displayed as -9999.

32 digits:

The left and right screen display, combined with the following figure to illustrate:

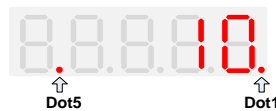

Dot1 is used to distinguish between the left and right screens. On indicates the left panel (upper 5 digits) and turns off the right screen (lower 5 digits). When the left screen is displayed, Dot5 is used to indicate the sign digit. On indicates that the value is negative, off indicates the value is Positive.

The display range of 32-bit unsigned numbers is 0 to 4294967295 (excluding decimal point), and the displayed range of signed numbers is -2147483648 to 2147483647 (excluding the decimal point).

◆ Binary data display

Binary number currently only supports 16 digits, points left and right screen display.

The leftmost digital tube is used to distinguish the left and right screens: the top digit segment lights up for the left panel and the bottom segment segment lights for the right panel.

Remove the leftmost digital tube, from right to left, followed by Bit0 ~ Bit15. The upper segment is lit to indicate 1,

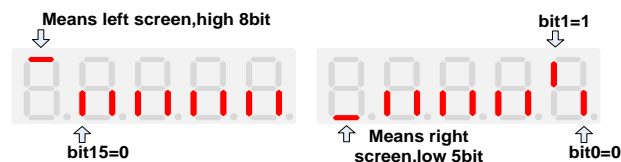

the lower segment to light to indicate 0.

◆ Parameter attribute identification

Editable parameters The leftmost LED displays "P"; the leftmost LED of the read-only parameter displays "r", as shown below.

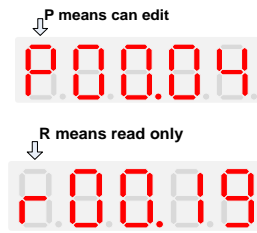

◆ Specific symbol

In some cases, the digital tube will display a specific symbol. The meaning of specific symbols is shown in the following table: Table4-2 Digital tube display symbol and meaning

Symbol	Meaning
tUnE	Motor parameter self-learning
bUSY	Processing parameter read and write requests
End	<ul style="list-style-type: none"> Indicates that the parameters have been changed and saved to the EEPROM The mission has been completed
Er.xxx	<ul style="list-style-type: none"> Fault code, "XXX" is the fault type, see Chapter 6 for details

4.4 Test run

Please follow the procedure below to commission the first time power-on.

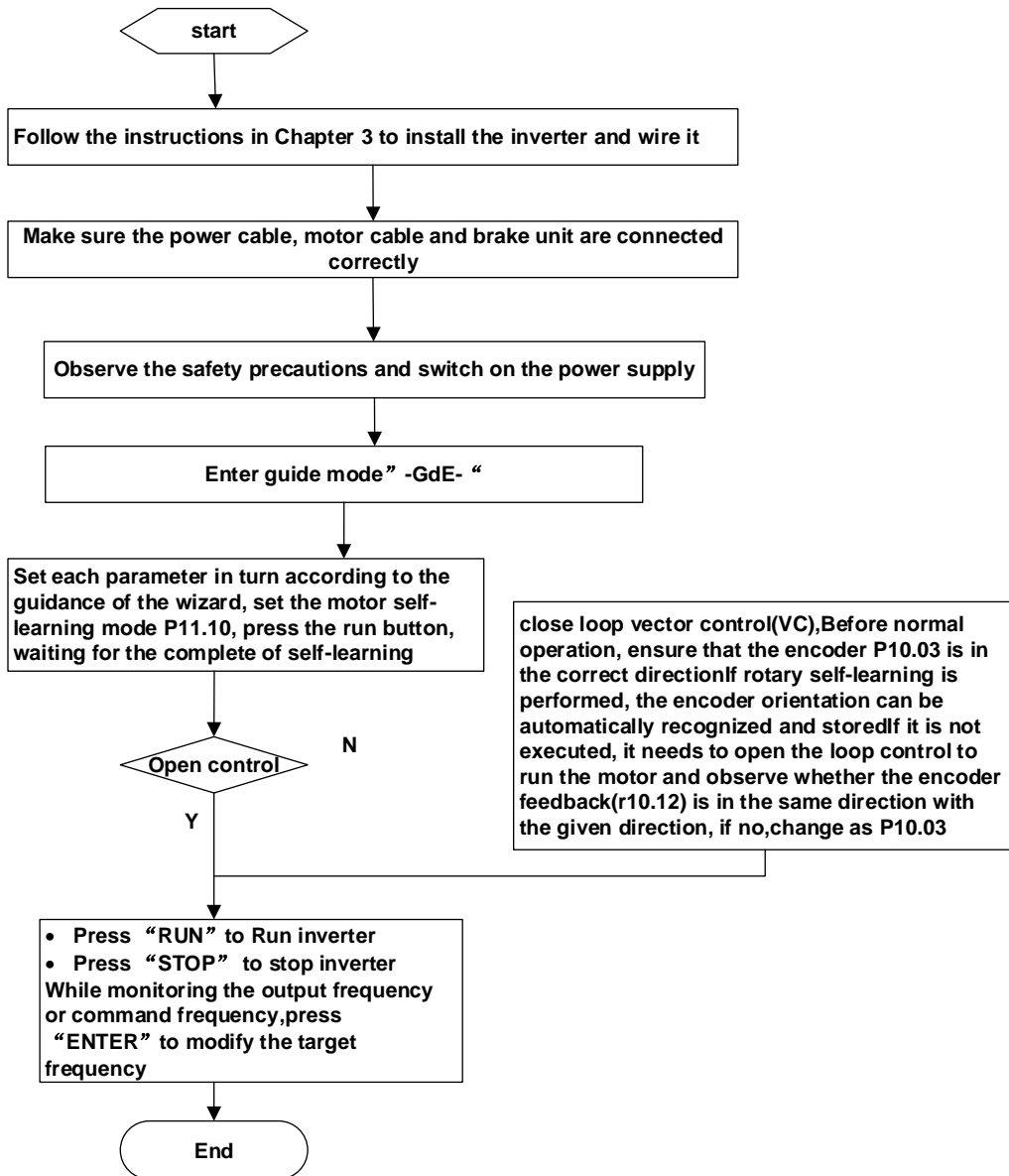

4-3 Trial run flow chart

Chapter 5 Function Code Table

The following is the VFD530 parameter distribution list:

Classification	Parameter group	Page
Common parameters	00:Basic function	Page 39
	01:Frequency source selection	Page 41
	02:Start and stop	Page 47
	03:Ramp and S curve	Page 51
	04: Analog and pulse input	Page 53
	05:Analog and pulse output	Page 57
	06:Multi-function Digital input (DI)	Page 58
	07: Multi-function Digital output(DO)	Page 61
	08:Digital Output setting	Page 64
Motor control	10:Encoder type	Page 67
	11:Motor1 parameter	Page 69
	12:Motor1 VFcontrol parameter	Page 71
	13:Motor1 Vector controlparameter	Page 75
	14:Torque control	Page 77
	16:Energy saving control	Page 78
	17:Synchronous motor control	Page 79
Display and protection	20>User-defined parameters	Page 80
	21:Keypad and display	Page 82
	22:AC Drive configuration	Page 84
	23:Drive protection function setting	Page 87
	24:Motor protection parameter	Page 90
	25:Fault tracking parameter	Page 92
	26:Fault recording parameter	Page 92
27:Monitoring parameter	Page 94	
Communication	30:Modbus communication	Page 95
	31:Canopen communication	Page 97
Application	40:Process PID Function	Page 97
	41:Sleep function	Page 104
	42:Simple PLC	Page 105
	43:Programmable delay unit	Page 107
	44:Comparator and logic unit/controller	Page 109
	45:Multifunction counter	Page 113
	50:PID2	Page 116
	51:Crane mechanism	Page 148
Motor 2	60:Motor2 basic parameter	Page 121
	61:Motor2 parameter	Page 121
	62:Motor2 VF control parameter	Page 121
	63:Motor2 vector control parameter	Page 121

Term Description:

The parameter is also called function code; the operation panel is also called the keyboard.

Due to usage habits, different terms may be used in different places in this manual, but all refer to the same content.

Symbol Description:

"☆" means that the setting value of this parameter can be changed when the inverter is stopped or running.

"★" means that the setting value of this parameter can not be changed when the inverter is running.

"●" indicates that the value of this parameter is the actual test record value, which can not be changed

Function code	Parameter name	Description	Default	Property
00Group Basic Function				
P00.00	User password	0 ~ 65535 ➤ No user password status after power-on (P00.01=1): The way to set a user password to lock is that Entering the same non-zero value two times in succession ➤ Locked status Enter the password to unlock ➤ Unlocked status Enter the original password to lock inverter; enter the same value twice in a row to change the password (password will be cleared if you enter 0 two times in a row).	0	☆
P00.01	Access authority	0: END USER Some parameter are not authorized to check when user password in locked state 1: Standard ALL Parameter can be checked	1	•
P00.02	Parameter copy and backup	0: No action 11: save all parameter to EEPROM backup space 12: Restore all parameter from EEPROM backup space	0	★
P00.03	RESET	0: NO ACTION 11: Restore default parameter except for motor parameter and auto-tune related parameter and factory parameter 12: Restore default to factory parameter 13: Clear tripping record	0	★
P00.04	Motor Control mode	0: VF 1: SVC(sensorless vector control) ➤ Open loop vector without encoder feedback and the feedback speed is internally estimated and supports torque control mode. 2: VC Vector control with sensor ➤ Close loop vector and torque control supporting encoder feedback in high precision or torque control application. The inverter must be equipped with a PG card that matches the encoder. For the relevant parameters of the PG card, please refer to P10 group	0	★

Function code	Parameter name	Description	Default	Property
P00.05	Running mode	0: Speed mode 1: Torque mode ➤ If use with DI function,19:Switch between torque and speed Control and 20: torque control disabled. Actual effective running mode is related with DI status	0	★
P00.06	Source of the Operation Command	0: keypad 1: terminal 2: communication ➤ Command source: run、 stop、 forward、 reverse、 jog、 fast brake stop.etc ➤ If use with DI function, 12: Switching run command to Keypad and 13: Switching run command to Communication,Actual effective command source is related with DI status	0	★
P00.07	Numeric frequency setting	00.00Hz~maximum frequency(Set P21.17=1 to change the unit to 1Rpm)	50.00Hz	☆
P00.08	Rotation direction	0: Forward 1: Reverse ➤ It is only for keypad control to change running direction by giving frequency symbol to be reverse)If command by keypad/terminal /communication,and not want to achieve reverse running by giving frequency symbol to be reverse,need to change P22.13 in stop mode(see parameter P22.13)	0	☆
P00.09	Reverse control	0: enable 1: disbale	0	★
P00.10	Motor option	0: motor 1 1: motor 2 If use with DI function,16:Switch between motor 1 and motor 2,Actual effective command source is related with DI status	0	★
P00.11	Special industry	0: standard drive 1: Reserved	0	★
r00.18	Power board software version	-	-	•
r00.19	Control board software version	-	-	•
r00.21	SN 1	-	-	•
r00.22	SN 2	-	-	•

Function code	Parameter name	Description	Default	Property
01Group frequency source selection				
P01.00	Main frequency source selection (A)	0: Digital setting 1: AI1 2: AI2 3: AI3(IO extension card) 4: AI4(IO extension card) 5: HDI 6: multi-step speed 7: communication 8: PID 9: Internal PLC Notice:DI terminal function code 26-32 superior than this function code	0	★
P01.01	Auxiliary frequency source selection (B)	Same as P01.00 Notice:DI terminal function code 33 superior than this function code	0	★
P01.02	Reference option for auxiliary frequency source	0: Relative to Maximum frequency 1: Relative to main frequency	0	★
P01.03	Auxiliary frequency gains	0.0~300.0	100.0%	☆
P01.04	Frequency source selection	0: main frequency sourceA 1: auxiliary frequency sourceB 2: Main and auxiliary arithmetic results 3: Switchover between main and auxiliary frequency 4: switchover between main frequency source A and A+B Arithmetic results 5: Switchover between B and (A+B) (*) DI function code 25 effective to corresponding terminal ,frequency will adopt the latter	0	★
P01.05	Main and Auxiliary arithmetic	0: A+B 1: A-B 2: The bigger of main A and Auxiliary B 3: The smaller of Main A and Auxiliary B 4: A*B A*B have better frequency adjustment ,wiel used for winding industry, fine sand machine, and leather, paper industry...	0	★
P01.06	Maximum frequency	10.00~600.00Hz	50.00Hz	★
P01.07	Upper limit frequency control	0: digital setting (set through P01.08) 1: AI1 2: AI2 3: Reserved	0	★

Function code	Parameter name	Description	Default	Property
		4: Reserved 5: Pulse setting HDI 6: Reserved 7: Communication setting		
P01.08	Upper limit frequency	Lower limit frequency(P01.09)~maximum frequency (P01.06)	50.00Hz	☆
P01.09	Lower limit frequency	0.00Hz~upper limit frequency	0.00Hz	☆
P01.10	Action when set frequency lower than lower limit frequency	0: Run at low limit frequency 1: Stop after delaying P01.11 2: Run at zero speed The inverter will coast to stop when the set frequency is lower than the lower-limit one.if the set frequency is above the lower limit one again and it lasts for the time set by P01.11, the inverter will come back to the running state automatically.	0	★
P01.11	Delay time when set frequency lower than lower limit frequency	0.000s~30.000s This function code determines the hibernation delay time. When the running frequency of the inverter is lower than the lower limit one, the inverter will stop to stand by.	0.000s	★
P01.12	Jump frequency start up protection	Unit/ten/hundred'digit: three jump frequency 1/2/3 0: Disable 1: Enable (avoid risk speed)	000	☆
P01.13	Jump frequency 1 lower limit	0.00Hz~(P01.14)	0.00Hz	☆
P01.14	Jump frequency upper limit	P01.13- (P01.06)Maximum frequency	0.00Hz	☆
P01.15	Jump frequency 2 lower limit	0.00Hz~(P01.16)	0.00Hz	☆
P01.16	Jump frequency 2 upper limit	P01.15~maximum frequency(P01.06)	0.00Hz	☆
P01.17	Jump frequency 3 lower limit	0.00Hz~(P01.18)	0.00Hz	☆
P01.18	Jump frequency 3 upper limit	P01.17~maximum frequency(P01.06)	0.00Hz	☆
<p>Risk speed or Jump frequency start up protection is used to some situation which need avoid motor speed and speed range,for example,due to mechanical resonance ,P01.12 will be enabled to avoide risk speed in forward or reverse mode</p>				

Function code	Parameter name	Description	Default	Property																																																																																					
<p>The graph shows a staircase-like relationship between 'Giving frequency' (x-axis) and 'Motor frequency' (y-axis). The frequency increases in steps. The steps are labeled with parameter codes: P01.13, P01.14, P01.15, P01.16, P01.17, and P01.18. Each step is represented by a horizontal line segment followed by a vertical jump. Arrows indicate the direction of the frequency change.</p>																																																																																									
P01.19	Multi-step speed reference source	Unit digit: 0 phase reference source set by 0-multi-step speed(P01.21) 1-preset frequency (P00.07) 2:A11 3:A12 4:A13(IO expansion board) 5:A14(IO expansion board) 6:HDI pulse 7:Communication 8:PID Ten's digit: Combination of multiple speed 0: Combination method 1: Priority method	00	★																																																																																					
Combination method Description: <table border="1" style="width: 100%; border-collapse: collapse; text-align: center;"> <thead> <tr> <th>Multispeed terminal 4</th> <th>Multispeed terminal 3</th> <th>Multispeed terminal 2</th> <th>Multispeed terminal 1</th> <th>Combination method Speed reference</th> </tr> </thead> <tbody> <tr><td>Ineffective</td><td>Ineffective</td><td>Ineffective</td><td>Ineffective</td><td>Multispeed 0</td></tr> <tr><td>Ineffective</td><td>Ineffective</td><td>Ineffective</td><td>effective</td><td>Multispeed 1</td></tr> <tr><td>Ineffective</td><td>Ineffective</td><td>effective</td><td>Ineffective</td><td>Multispeed 2</td></tr> <tr><td>Ineffective</td><td>Ineffective</td><td>effective</td><td>effective</td><td>Multispeed 3</td></tr> <tr><td>Ineffective</td><td>effective</td><td>Ineffective</td><td>Ineffective</td><td>Multispeed 4</td></tr> <tr><td>Ineffective</td><td>effective</td><td>Ineffective</td><td>effective</td><td>Multispeed 5</td></tr> <tr><td>Ineffective</td><td>effective</td><td>effective</td><td>Ineffective</td><td>Multispeed 6</td></tr> <tr><td>Ineffective</td><td>effective</td><td>effective</td><td>effective</td><td>Multispeed 7</td></tr> <tr><td>effective</td><td>Ineffective</td><td>Ineffective</td><td>Ineffective</td><td>Multispeed 8</td></tr> <tr><td>effective</td><td>Ineffective</td><td>Ineffective</td><td>effective</td><td>Multispeed 9</td></tr> <tr><td>effective</td><td>Ineffective</td><td>effective</td><td>Ineffective</td><td>Multispeed 10</td></tr> <tr><td>effective</td><td>Ineffective</td><td>effective</td><td>effective</td><td>Multispeed 11</td></tr> <tr><td>effective</td><td>effective</td><td>Ineffective</td><td>Ineffective</td><td>Multispeed 12</td></tr> <tr><td>effective</td><td>effective</td><td>Ineffective</td><td>effective</td><td>Multispeed 13</td></tr> <tr><td>effective</td><td>effective</td><td>effective</td><td>Ineffective</td><td>Multispeed 14</td></tr> <tr><td>effective</td><td>effective</td><td>effective</td><td>effective</td><td>Multispeed 15</td></tr> </tbody> </table>					Multispeed terminal 4	Multispeed terminal 3	Multispeed terminal 2	Multispeed terminal 1	Combination method Speed reference	Ineffective	Ineffective	Ineffective	Ineffective	Multispeed 0	Ineffective	Ineffective	Ineffective	effective	Multispeed 1	Ineffective	Ineffective	effective	Ineffective	Multispeed 2	Ineffective	Ineffective	effective	effective	Multispeed 3	Ineffective	effective	Ineffective	Ineffective	Multispeed 4	Ineffective	effective	Ineffective	effective	Multispeed 5	Ineffective	effective	effective	Ineffective	Multispeed 6	Ineffective	effective	effective	effective	Multispeed 7	effective	Ineffective	Ineffective	Ineffective	Multispeed 8	effective	Ineffective	Ineffective	effective	Multispeed 9	effective	Ineffective	effective	Ineffective	Multispeed 10	effective	Ineffective	effective	effective	Multispeed 11	effective	effective	Ineffective	Ineffective	Multispeed 12	effective	effective	Ineffective	effective	Multispeed 13	effective	effective	effective	Ineffective	Multispeed 14	effective	effective	effective	effective	Multispeed 15
Multispeed terminal 4	Multispeed terminal 3	Multispeed terminal 2	Multispeed terminal 1	Combination method Speed reference																																																																																					
Ineffective	Ineffective	Ineffective	Ineffective	Multispeed 0																																																																																					
Ineffective	Ineffective	Ineffective	effective	Multispeed 1																																																																																					
Ineffective	Ineffective	effective	Ineffective	Multispeed 2																																																																																					
Ineffective	Ineffective	effective	effective	Multispeed 3																																																																																					
Ineffective	effective	Ineffective	Ineffective	Multispeed 4																																																																																					
Ineffective	effective	Ineffective	effective	Multispeed 5																																																																																					
Ineffective	effective	effective	Ineffective	Multispeed 6																																																																																					
Ineffective	effective	effective	effective	Multispeed 7																																																																																					
effective	Ineffective	Ineffective	Ineffective	Multispeed 8																																																																																					
effective	Ineffective	Ineffective	effective	Multispeed 9																																																																																					
effective	Ineffective	effective	Ineffective	Multispeed 10																																																																																					
effective	Ineffective	effective	effective	Multispeed 11																																																																																					
effective	effective	Ineffective	Ineffective	Multispeed 12																																																																																					
effective	effective	Ineffective	effective	Multispeed 13																																																																																					
effective	effective	effective	Ineffective	Multispeed 14																																																																																					
effective	effective	effective	effective	Multispeed 15																																																																																					

Function code	Parameter name	Description	Default	Property																														
Priority method Description:																																		
<table border="1"> <thead> <tr> <th>Multispeed terminal 4</th> <th>Multispeed terminal 3</th> <th>Multispeed terminal 2</th> <th>Multispeed terminal 1</th> <th>Priority method Speed reference</th> </tr> </thead> <tbody> <tr> <td>Ineffective</td> <td>Ineffective</td> <td>Ineffective</td> <td>Ineffective</td> <td>Multispeed 0</td> </tr> <tr> <td>Ineffective</td> <td>Ineffective</td> <td>Ineffective</td> <td>effective</td> <td>Multispeed 1</td> </tr> <tr> <td>Ineffective</td> <td>Ineffective</td> <td>effective</td> <td>random</td> <td>Multispeed 2</td> </tr> <tr> <td>Ineffective</td> <td>effective</td> <td>random</td> <td>random</td> <td>Multispeed 3</td> </tr> <tr> <td>effective</td> <td>random</td> <td>random</td> <td>random</td> <td>Multispeed 4</td> </tr> </tbody> </table>					Multispeed terminal 4	Multispeed terminal 3	Multispeed terminal 2	Multispeed terminal 1	Priority method Speed reference	Ineffective	Ineffective	Ineffective	Ineffective	Multispeed 0	Ineffective	Ineffective	Ineffective	effective	Multispeed 1	Ineffective	Ineffective	effective	random	Multispeed 2	Ineffective	effective	random	random	Multispeed 3	effective	random	random	random	Multispeed 4
Multispeed terminal 4	Multispeed terminal 3	Multispeed terminal 2	Multispeed terminal 1	Priority method Speed reference																														
Ineffective	Ineffective	Ineffective	Ineffective	Multispeed 0																														
Ineffective	Ineffective	Ineffective	effective	Multispeed 1																														
Ineffective	Ineffective	effective	random	Multispeed 2																														
Ineffective	effective	random	random	Multispeed 3																														
effective	random	random	random	Multispeed 4																														
P01.20	Multiple step speed Rotation direction	Bit0 ~ 15 corresponding to 0 ~ 15 phase direction 0:forward direction 1:reverse direction	0	☆																														
P01.21	Multiple step speed 0/in-built plc 1	Lower limit frequency (P01.09) ~ maximum frequency(P01.06) Note: When the unit's digit of P01.19 is set to non-zero, this setting is invalid.	0.00Hz	☆																														
P01.22	Multiple step speed 1/in-built plc 2	Lower limit frequency(P01.09) ~ maximum frequency(P01.06)	0.00Hz	☆																														
P01.23	Multiple step speed 2/in-built plc 3	Lower limit frequency(P01.09) ~ maximum frequency(P01.06)	0.00Hz	☆																														
P01.24	Multiple step speed 3/in-built plc 4	Lower limit frequency(P01.09) ~ maximum frequency(P01.06)	0.00Hz	☆																														
P01.25	Multiple step speed 4/in-built plc 5	Lower limit frequency(P01.09) ~ maximum frequency(P01.06)	0.00Hz	☆																														
P01.26	Multiple-step speed 5/in-built plc 6	Lower limit frequency(P01.09) ~ maximum frequency(P01.06)	0.00Hz	☆																														
P01.27	Multiple step speed 6/in-built plc 7	Lower limit frequency(P01.09) ~ maximum frequency(P01.06)	0.00Hz	☆																														
P01.28	Multiple step speed 7/in-built plc 8	Lower limit frequency(P01.09) ~ maximum frequency(P01.06)	0.00Hz	☆																														
P01.29	Multiple step speed 8/in-built plc 9	Lower limit frequency(P01.09) ~ maximum frequency(P01.06)	0.00Hz	☆																														
P01.30	Multiple step speed 9/in-built plc 10	Lower limit frequency(P01.09) ~ maximum frequency(P01.06)	0.00Hz	☆																														
P01.31	Multiple step speed 10/in-built plc 11	Lower limit frequency(P01.09) ~ maximum frequency(P01.06)	0.00Hz	☆																														
P01.32	Multiple step speed 11/in-built plc 12	Lower limit frequency(P01.09) ~ maximum frequency(P01.06)	0.00Hz	☆																														
P01.33	Multiple step speed 12/in-built plc 13	Lower limit frequency(P01.09)~maximum frequency(P01.06)	0.00Hz	☆																														
P01.34	Multiple step speed	Lower limit frequency(P01.09)~maximum	0.00Hz	☆																														

Function code	Parameter name	Description	Default	Property
	13/in-built plc 14	frequency(P01.06)		
P01.35	Multiple step speed 14/in-built plc 15	Lower limit frequency(P01.09)~maximum frequency(P01.06)	0.00Hz	☆
P01.36	Multiple step speed 15/in-built plc 16	Lower limit frequency(P01.09)~maximum frequency(P01.06)	0.00Hz	☆
P01.37	Jog frequency	0.00Hz~maximum frequency(P01.06)	5.00Hz	☆
P01.38	Jog command when running	0: not responsive 1: responsive	0	★
P01.39	UP/DOWN rates	0.00(auto rates)~600.00Hz/s	1.00Hz/s	☆
P01.40	UP/DOWN Control	Unit' digit: 0: Zero clearing in non-running 1: Zero clearing when UP/DOWN command not effective 2: Not zero cleaning (decide by remembering digit when power failure Ten's digit: 0: Non-zero cleaning at power failure 1: Save at power failure UP/DOWN offset Hundred's digit: UP/DOWN near to zero 0: Forbidden 1: Enable Thousand's digit up and down action mode 0: Superposition 1: Gain effect	0002	★
P01.41	Droop control gains	0.00~1.00 Rotation speed drop value based on Rated load (relative to maximum frequency) Frequency drop volume: Max frequency*P01.41*Current load/rated load	0.00	☆
P01.42	Droop control filtering time	0.000s~10.000s	0.050s	☆
<p>When several motors drive the same load, each motor's load is different because of the difference of motor's rated speed. The load of different motors can be balanced through droop control function which makes the speed droop along with load increase.</p> <p>When the motor outputs rated torque, actual frequency drop is equal to P1.41. User can adjust this parameter from small to big gradually during commissioning.</p>				
P01.43	Textile frequency setting	0: relative to center of textile frequency 1: relative to maximum frequency	0	☆
P01.44	Textile frequency	0.0%~100% relative to center of textile frequency P01.43 = 0Textile frequency Aw = P01.44 * center frequency	0.0%	☆

Function code	Parameter name	Description	Default	Property
		P01.43 = 1: Textile frequency $A_w = P01.44 * \text{max frequency}$		
P01.45	Jump frequency	0.0%~50.0% relative to textile frequency	0.0%	☆
P01.46	Textile period	0.1s~3000.0s	10.0s	☆
P01.47	Triangle wave rising time coefficient	0.1%~100.0% relative to textile period	50.0%	☆

This function is mostly used in textile and chemical industry and some application such as traversing and winding so it is used for balancing the workload allocation when multiple motors are used to drive the same load. The output frequency of the frequency inverters decreases as the load increases. You can reduce the workload of the motor under load by decreasing the output frequency for this motor, implementing workload balancing among multiple motors. **P01.44 or P01.46=0, This function disable**

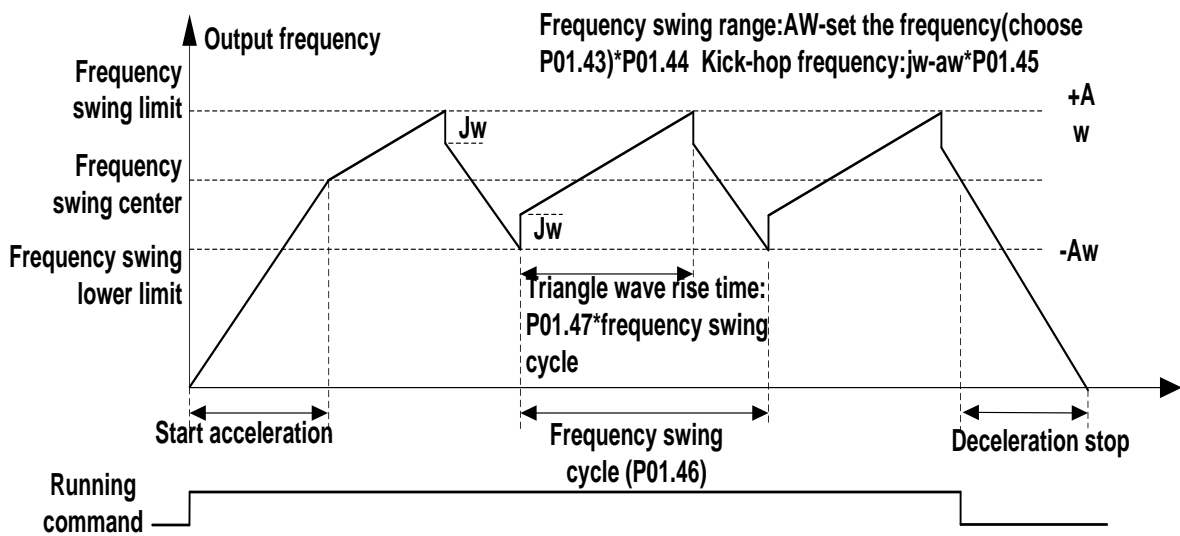

P01.48	Auxiliary frequency effective threshold	When the main frequency \geq this setting, the auxiliary frequency will be effective	0.00Hz	☆
--------	---	--	--------	---

Function code	Parameter name	Description	Default	Property
02 Group Start and stop Control				
P02.00	Starting mode	<p>0: Direct start Inverter will start from P02.01,After P02.02,It will go to setting frequency as per S curve</p> <p>1: Speed tracking/Searching Inverter will do search for motor speed and recognize and accelerate and decelerate to setting frequency.See Parameter P02.16-P02.19</p> <p>The direction and speed will be tracked automatically for the smoothing starting of rotating motors. It suits the application with reverse rotation when big load starting.</p>	0	★
P02.01	Startup frequency	0.00Hz~10.00Hz	0.00Hz	★
P02.02	Startup frequency holding time	<p>0.000s~10.000s</p> <p>Set a proper starting frequency to increase the torque of the inverter during starting. During the retention time of the starting frequency, the output frequency of the inverter is the starting frequency. And then, the inverter will run from the starting frequency to the set frequency. If the set frequency is lower than the starting frequency, the inverter will stop running and keep in the stand-by state. The starting frequency is not limited in the lower limit frequency.</p>	0.000s	★
P02.03	Quick-response excitation	<p>0: Disable</p> <p>1: Enable</p> <p>Set 1= enable it will automatically calculate pre-excitation current P02.04 and pre-excitation time ,after finishing calculation,this parameter will reset to 0</p>	0	★
P02.04	Pre-excitation current	0%~200% motor rated current	Depend	★
P02.05	Pre-excitation time	<p>0.00s~10.00s</p> <p>Pre-excitation enable Asynchronous motor for magnetic field for higher starting torque</p>	Depend	★
P02.06	DC brake current at start-up	0~100% motor rated current	100%	☆
P02.07	DC brake time at start-up	<p>0.000s~30.000s</p> <p>No start DC brake when set to 0s</p>	0.000s	★

Function code	Parameter name	Description	Default	Property
<p>DC braking is used to make the running motor stop & restart. Pre-excitation is used to establish asynchronous motor magnetic field, then start, improve the response speed.</p> <p>DC braking is only valid when start directly, the inverter performs DC braking according to P02-06 firstly, and runs after P02-07. If DC braking time is 0, the inverter starts directly. The bigger the DC braking current is, the greater the braking force</p> <p>If the start mode is pre-excitation start, then the inverter establishes magnetic field according to the set pre-excitation current firstly, runs after the set pre-excitation time. If the pre-excitation time is 0, the inverter starts directly.</p> <p>DC braking current before start/pre-excitation current refers to the percentage of the inverter rated current.</p>				
P02.08	Stop method	<p>0: ramp to stop after the stop command becomes valid, the inverter decelerates to reduce the output frequency during the set time. When the frequency decreases to 0Hz, the inverter stops.</p> <p>1: free coast to stop after the stop command becomes valid, the inverter ceases the output immediately. And the load coasts to stop at the mechanical inertia.</p>	0	☆
P02.09	Startup frequency of DC brake at stop	<p>0.00Hz~50.00Hz start the DC braking when running frequency reaches starting frequency determined by P02.09.</p>	1.00Hz	★
P02.10	DC braking current at stop	<p>0~200% motor rated current(Maximum value not higher than drive rated current) the value of P02.10 is the percentage of rated current of inverter. The bigger the DC braking current is, the greater the braking torque is DC braking time: the retention time of DC braking. If the time is 0, the DC braking is invalid. The inverter will stop at the set deceleration time.</p>	100%	☆
P02.11	DC brake time at stop	<p>0.000s~30.000s Inverters blocks the output before starting the DC braking. After this waiting time, the DC braking will be started so as to prevent over-current</p>	0.000s	★

Function code	Parameter name	Description	Default	Property
		fault caused by DC braking at high speed.		
P02.12	Magnetic flux brake gain	<p>1.00~1.50</p> <p>Over excitation braking convert some kinetic energy to motor heating by increasing motor excitation.value 1 means ineffective: value higher,better performance but output current bigger</p> <p>This inverter can slow down the motor by increasing the magnetic flux. The energy generated by the motor during braking can be transformed into heat energy by increasing the magnetic flux. The inverter monitors the state of the motor continuously even during the magnetic flux period. So the magnetic flux can be used in the motor stop, as well as to change the rotation speed of the motor. Its other advantages are: Brake immediately after the stop command. It does not need to wait the magnetic flux weaken.</p> <p>The cooling is better. The current of the stator other than the rotor increases during magnetic flux braking, while the cooling of the stator is more effective than the rotor.</p>	1.00	★
P02.13	Delaying frequency at stop	0.00Hz~20.00Hz	0.50Hz	★
P02.14	Delaying time at stop	<p>0.000s~60.000s</p> <p>0.000s:no function for delaying time at stop >0.000s:it is effective,when output frequency decrease lower than delaying frequency at stop (P02.13),inverter will block pulse output after delaying time at stop (P02.14).if run command comes during delaying time,inverter will restart.it is useful to some application with jog function</p>	0.000s	★
P02.15	The minimum blocking time after free stop	0.010s~30.000s	Depend	★
P02.16	Speed tracking mode	<p>Unit's digit: tracking mode</p> <p>0 : Speed tracking for maximum output frequency</p>	00	★

Function code	Parameter name	Description	Default	Property
		1: Speed tracking for frequency at stop 2: Speed tracking for grid frequency Ten's digit: direction choosing 0: only search at given frequency direction 1: search on the other direction when failed for given frequency tracking		
P02.17	Deceleration time for speed search	0.1s~20.0s	2.0s	★
P02.18	Current for speed search	10%~150% motor rated current	40%	★
P02.19	Speed search compensation factor	0.00~10.00	1.00	★

Function code	Parameter name	Description	Default	Property
03 Group Ramp and S curve				
P03.00	Acceleration and deceleration curve selection	0: linear 1: S curve A 2: S curve B	0	★
<p>Acceleration and deceleration curve, also known as "Ramp Frequency Generator (RFG)", is used to smooth the frequency command. VFD530 supports the following acceleration and deceleration curve:</p> <p>0: linear acceleration / deceleration</p> <p>The output changes at a constant acceleration or deceleration. Acceleration time refers to the time from when the inverter accelerates from zero to the reference frequency (selected by P03.15); deceleration time refers to the time required to decelerate from the reference frequency to zero.</p> <p>1: S curve method</p> <p>This acceleration and deceleration curve acceleration "a" changes in a ramp, start and stop relatively flat. Acceleration and deceleration process as shown below, T_{acc} and T_{dec} for the set acceleration and deceleration time.</p> <p>The acceleration and deceleration curve of the equivalent acceleration and deceleration time:</p> <p>Acceleration time = T_{acc} + (T_{s1} + T_{s2}) / 2</p> <p>Deceleration time = T_{dec} + (T_{s3} + T_{s4}) / 2</p> <div style="text-align: center;"> <p>The graph shows the output frequency recommendation over time. The acceleration phase is characterized by a smooth curve that starts at zero and reaches a steady state. The deceleration phase is also smooth, starting from the steady state and returning to zero. The total acceleration time is T_{acc}, and the total deceleration time is T_{dec}. The acceleration phase is further divided into segments T_{s1} and T_{s2}, while the deceleration phase is divided into T_{s3} and T_{s4}.</p> </div> <p>2: S curve method B</p> <p>The time of this S-curve is defined as in the method A except that in the acceleration / deceleration process, if the target frequency suddenly approaches or the acceleration / deceleration time changes, the S-curve is re-planned. In addition, when the target frequency changes, the S Curves avoid "overshoot" as much as possible.</p>				
P03.01	Acceleration time 1	Setting value depend on P03.16 P03.16 = 2, 0.00~600.00s; P03.16 = 1, 0.0s~6000.0s; P03.16 = 0, 0s~60000s	Depend on model	☆
P03.02	Deceleration time 1	Setting value depend on P03.16 P03.16 = 2, 0.00~600.00s; P03.16 = 1, 0.0s~6000.0s; P03.16 = 0, 0s~60000s	Depend on model	☆
P03.03	Acceleration time2	0.01~60000s same as P03.01	Depend on model	☆
P03.04	Deceleration time2	0.01~60000s same as P03.02	Depend on model	☆
P03.05	Acceleration time3	0.01~60000s same as P03.01	Depend on model	☆

Function code	Parameter name	Description	Default	Property
P03.06	Deceleration time3	0.01~60000s same as P03.02	Depend on model	☆
P03.07	Acceleration time4	0.01~60000s same as P03.01	Depend on model	☆
P03.08	Deceleration time4	0.01~60000s same as P03.02	Depend on model	☆

The VFD530 provides four groups of acceleration and deceleration time. The actual acceleration / deceleration time can be selected by different methods such as DI terminal, output frequency and PLC running segments. Several methods can not be used at the same time. Factory default is to use acceleration / deceleration time

1. DI terminal select acceleration and deceleration time of the mapping table is as follows :

Acceleration and deceleration time DI terminal 2	Acceleration and deceleration time DI terminal 1	Acceleration and deceleration time
Ineffective	Ineffective	Acceleration and deceleration time terminal 1 (P03.01,P03.02)
Ineffective	Effective	Acceleration and deceleration time terminal 2 (P03.03,P03.04)
Effective	Ineffective	Acceleration and deceleration time terminal 3 (P03.05,P03.06)
Effective	Effective	Acceleration and deceleration time terminal 4 (P03.07,P03.08)

The schematic diagram of selecting acceleration / deceleration time according to the output frequency is as follows:

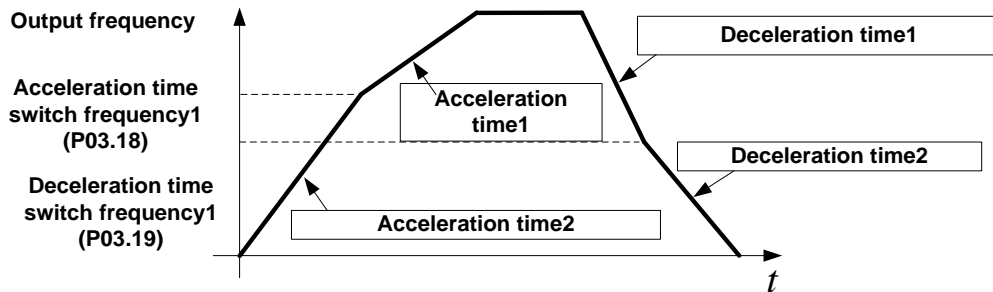

Other ways to select acceleration / deceleration time can be found in the description of relevant parameters .

P03.09	Jog Acceleration time	Time Setting same as P03.01	6.00s	☆
P03.10	Jog Deceleration time	Time Setting same as P03.02	10.00s	☆
P03.11	S-curve Acceleration begin time	Setting value depend on P03.16 P03.16 = 2, 0.01~30.00s; P03.16 = 1, 0.1s~300.0s; P03.16 = 0, 1s~3000s	0.50s	☆
P03.12	S-curve Acceleration arrival time	SAME AS P03.11	0.50s	☆
P03.13	S-curve Deceleration	SAME AS P03.11	0.50s	☆

Function code	Parameter name	Description	Default	Property	
	begin time				
P03.14	S-curve Deceleration Arrival time	SAME AS P03.11	0.50s	☆	
P03.15	Accel and Deceltime frequency benchmark	0: Maximum frequency 1: Motor rated frequency	0	★	
P03.16	Accel and Decel time unit selection	0: 1s 1: 0.1s 2: 0.01s	2	★	
P03.17	Quickstop deceleration time	0.01~65000s	5.00s	☆	
P03.18	Switchingfrequency 1 in acceleration time	0.00Hz~maximum frequency(P01.06)	0.00Hz	☆	
P03.19	Switchingfrequency 1 in deceleration time	0.00Hz~maximum frequency(P01.06)	0.00Hz	☆	
P03.20	Forward/reverse Dead band time	0.00s~30.00s Waiting time for zero speed during forward and reverse switchover	0.00s	★	
04 Group Analog and Pulse input					
P04.00	Minimum input pulse frequency	0.00kHz~ 50.00kHz	<p>Corresponding setting</p> <p>HDI input frequency</p>	1.00kHz	☆
P04.01	Maximum input pulse frequency	0.00kHz~ 50.00kHz		30.00kHz	☆
P04.02	Setting Corresponding to Minimum input	-100.0%~ 100.0%		0.0%	☆
P04.03	Setting Corresponding to maximum input	-100.0%~ 100.0%		100.0%	☆
P04.04	Pulse input filter time	0.000s~10.000s	0.050s	☆	
r04.05	Pluse input frequency	0.00kHz~50.00kHz(it is used to check HDI pulse input frequency)	-	●	
r04.06	HDI equivalent value	-100.0%~100.0%(it is used to View the output of the HDI mapping curve)	-	●	
P04.07	AI 1 Curve setting	Unit's: AI curve selection 0: curve A 1: curve B	00	★	

Function code	Parameter name	Description	Default	Property
		2: Curve C 3: Curve D Ten'unit: when input signal lower than minimum input 0: equal to minimum input 1: equal to 0.0%		
P04.08	AI1 filter time	0.000s~10.000s	0.100s	☆
r04.09	AI 1 actual value	0.00V~10.00V (it is used to view the port voltage of AI1. When AI1 is a current type (0~20mA) input, multiplying this value by 2 is the input current (mA) of the AI1 port.)	-	●
r04.10	AI 1 Conversion value	-100.0%~100.0%(It is used to view the output of the AI1 mapped curve)	-	●
P04.11	AI 2 Curve setting	Unit's: AI curve selection 0: curve A 1: curve B 2: Curve C 3: Curve D Ten'unit: when input signal lower than minimum input 0: equal to minimum input 1: equal to 0.0%	01	★
P04.12	AI2 filter time	0.000s~10.000s	0.100s	☆
r04.13	AI 2 actual value	0.00V~10.00V (it is used to view the port voltage of AI2. When AI2 is a current type (0~20mA) input, multiplying this value by 2 is the input current (mA) of the AI2 port.)	-	●
r04.14	AI 2 Conversion value	-100.0%~100.0%(It is used to view the output of the AI2 mapped curve)	-	●
P04.15	AI 3(option card) Curve setting	Unit's: AI curve selection 0: curve A 1: curve B 2: Curve C 3: Curve D Ten'unit: when input signal lower than minimum input 0: equal to minimum input 1: equal to 0.0%	02	★
P04.16	AI3 (option card) filter time	0.000s~10.000s	0.100s	☆
r04.17	AI3(option card) actual value	0.00V~10.00V (it is used to view the port voltage of AI3. When AI3 is a current type (0~20mA) input, multiplying this value by 2 is the input current (mA) of the AI3 port.)	-	●
r04.18	AI3(option card) Conversion value	-100.0%~100.0%(It is used to view the output of the AI3 mapped curve)	-	●
P04.19	AI 4(option card) Curve setting	Unit's: AI curve selection 0: curve A 1: curve B 2: Curve C	03	★

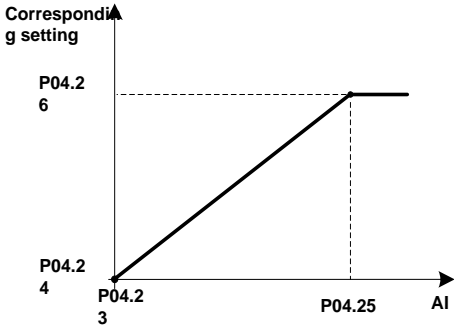
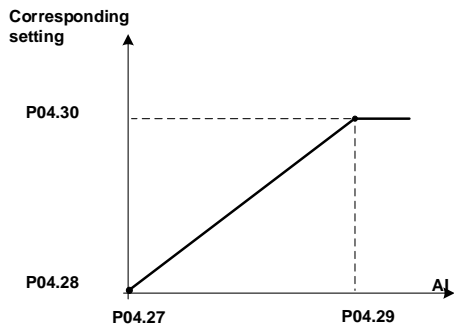
Function code	Parameter name	Description		Default	Property
		3: Curve D Ten'unit: when input signal lower than minimum input 0: equal to minimum input 1: equal to 0.0%			
P04.20	AI4(option card) filter time	0.000s~10.000s		0.100s	☆
r04.21	AI4(option card) actual value	0.00V~10.00V (it is used to view the port voltage of AI4. When AI4 is a current type (0~20mA) input, multiplying this value by 2 is the input current (mA) of the AI4 port.)		-	●
r04.22	AI4(option card) Conversion value	-100.0%~100.0%(It is used to view the output of the AI4 mapped curve)		-	●
P04.23	Curve A horizontal axis 1	0.00V~ P04.25	 <p>Note:input less than P04.23,output decided by curve ten's digit</p>	0.00V	☆
P04.24	Curve A vertical axis 1	-100.0%~ 100.0%		0.0%	☆
P04.25	Curve A horizontal axis 2	P04.23~ 10.00V		10.00V	☆
P04.26	Curve A vertical axis 2	-100.0%~ 100.0%		100.0%	☆
Setting method mode for AI1 4~20mA form 1. Switch the corresponding AI1 jumper on the IO board to current; 2. Set the function code: P04.07 Unit's place=0 (default), P04.23=2.00.					
P04.27	Curve B horizontal axis 1	0.00V~ P04.29	 <p>if you want to use 4-20MA,Set 04.27=2.00V Note:input less than P04.27,output decide by curve ten's digit</p>	0.00V	☆
P04.28	Curve B vertical axis 1	-100.0%~ 100.0%		0.0%	☆
P04.29	Curve B horizontal axis 2	P04.27~ 10.00V		10.00V	☆
P04.30	Curve B vertical axis 2	-100.0%~ 100.0%		100.0%	☆
Setting method mode for AI1 4~20mA form 1. Switch the corresponding AI1 jumper on the IO board to current; 2. Set the function code: P04.11 one place=1 (default), P04.27=2.00					
P04.31	Curve C horizontal axis 1	0.00V~ P04.33		0.00V	☆

Function code	Parameter name	Description	Default	Property
P04.32	Curve C vertical axis 1	-100.0%~100.0%	0.0%	☆
P04.33	Curve C horizontal axis 2	P04.31~P04.35	3.00V	☆
P04.34	Curve C vertical axis 2	-100.0%~100.0%	30.0%	☆
P04.35	Curve C horizontal axis 3	P04.33~P04.37	6.00V	☆
P04.36	Curve C vertical axis 3	-100.0%~100.0%	60.0%	☆
P04.37	Curve C horizontal axis 4	P04.35~10.00V	10.00V	☆
P04.38	Curve C vertical axis 4	-100.0%~100.0%	100.0%	☆
P04.39	Curve D horizontal axis 1	0.00V~P04.41	0.00V	☆
P04.40	Curve D vertical axis 1	-100.0%~100.0%	0.0%	☆
P04.41	Curve D horizontal axis 2	P04.39~P04.43	3.00V	☆
P04.42	Curve D vertical axis 2	-100.0%~100.0%	30.0%	☆
P04.43	Curve D horizontal axis 3	P04.41~P04.45	6.00V	☆
P04.44	Curve D vertical axis 3	-100.0%~100.0%	60.0%	☆
P04.45	Curve D horizontal axis 4	P04.43~10.00V	10.00V	☆
P04.46	Curve D vertical axis 4	-100.0%~100.0%	100.0%	☆

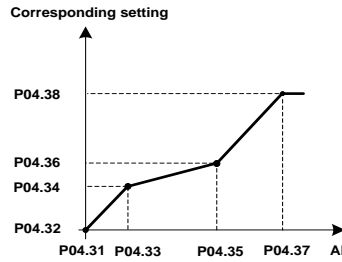

Note:input less than P04.31,output decided by curve ten's digit

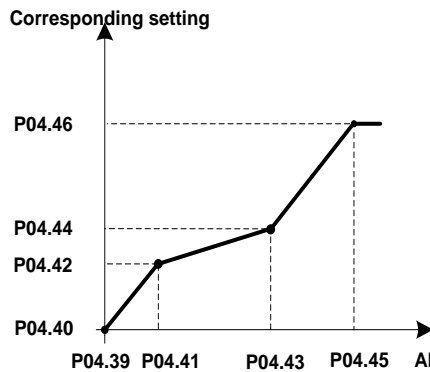

Note:input less than P04.39,output decided by curve ten's digit

Description: The range of HDI, AI1 ~ AI4 mapping curve:

- For frequency setting, 100% corresponds to the maximum frequency P01.06.
- For torque setting, 100% corresponds to the maximum torque P14.02.
- For other uses, see the description of the relevant function.

05 Group Analog and Pulse output				
r05.00	Actual output Pulse frequency	0.00kHz~50.00kHz	-	●
P05.01	HDO Pulse Output type	0: Common numeric output (DO2 P07.02) 1: high frequency pulse output (Hdo)	0	☆
P05.02	HDO output source selection	0: Running frequency (0~max frequency) 1: Set frequency (0~max frequency) 2: output current (0~2times motor rated current) 3: output torque(0~3times motor rated torque) 4: set torque(0~3times motor rated torque) 5: output voltage (0~2times motor rated voltage) 6: DC bus voltage (0~2times drives standard DC bus voltage) 7: output power (0~2times motor rated power) 8:encoder rotating speed(0-maximum frequency rotating speed) 9: AI1 (0.00~10.00V) 10: AI2 (0.00~10.00V) 11: AI3 (0.00~10.00V) 12: AI4 (0.00~10.00V) 13: 10V (full-scale output, the actual output voltage is subject to measurement) 14: PID2 (0.00~10.00V)	0	☆
P05.03	HDO Minimum output pulse frequency	0.00kHz~50.00kHz HDO terminal output pulse frequencywhen Output signal source=0	1.00kHz	☆
P05.04	HDO Max output pulse frequency	0.00kHz~50.00kHz HDO terminal output pulse frequencywhen Output signal source=maximum value	30.00kHz	☆
r05.05	AO1 actual value	0.0%~100.0%	-	●
P05.06	AO1 output function signal selection	Same as P05.02 function description	0	☆
P05.07	AO1 output offset	-100.0%~100.0%	0.0%	☆
P05.08	AO1 output gain	-10.00~10.00	1.00	☆
<p>The output error of AO1 can be corrected by P05.07 and P05.08, or the mapping relationship between signal source and actual output can be changed. The formula is: $AO.c = P05.07 + P05.08 \times AO.p$ AO.c: the actual output of AO1; AO.p: AO1 Value before correction and AO.c, AO.p, 100.0% of P05.07 corresponds to 10V or 20mA. Example: AO1 is set to 4~20mA output: 1. Switch the corresponding AO1 jumper on the IO board to current 2. Set the function code: P05.07=20.0%, P05.08=0.80</p>				
r05.09	AO2 actual value	0.0%~100.0%	-	●
P05.10	AO2 output function signal	Same as P05.02 function description	0	☆

	selection			
P05.11	AO2 output offset	-100.0%~100.0%	0.0%	☆
P05.12	AO2 gain	-10.00~10.00	1.00	☆

The output error of AO2 can be corrected by P05.11 and P05.12, or the mapping relationship between signal source and actual output can be changed. The formula is:
 $AO.c = P05.11 + P05.12 \times AO.p$
 AO.c: the actual output of AO2;
 AO.p: AO2 value before correction and **AO.c, AO.p, 100.0% of P05.11 corresponds to 10V or 20mA.**
Example: Such as: AO2 is set to 4~20mA output:
1. Switch the corresponding AO2 jumper on the IO board to current
2. Set the function code: P05.11=20.0%, P05.12=0.80

06 Group Multi-function Digital input				
r06.00	DI port status	Bit0~Bit8 Correspond to DI1~DI8 Bit12~Bit15 Correspond to VDI1~VDI4	-	●
P06.01	DI1 Numeric input function	0: No function 1: FORWARD 2: Reverse/Forward and reverse switchover 3: Three wire control 4: Forward jog command 5: Reverse jog command	1	★
P06.02	DI2 Numeric input function	6: Terminal UP 7: Terminal DOWN 8: Clear up UP/DOWN offset 9: Coast to stop/free stop	2	★
P06.03	DI3 Numeric input function	10: Fault reset 11: Reverse forbidden 12: Switching run command to Keypad 13: Switching run command to Communication 14: fast stop 15: external stop	4	★
P06.04	DI4 Numeric input function	16: Switch between motor 1 and motor 2 17: Pause operatoin 18: DC braking 19: Switch between torque and speed Control 20: Torque control dabled 21: Multi-step speed terminal 1 22: Multi-step speed terminal2	10	★
P06.05	DI5(HDI) Numeric input function	23: Multi-step speedterminal3 24: Multi-step speed terminal4 25: Frequency source switchover 26: Switch main frequency source to Numeric frequency setting	0	★
P06.06	DI6 Numeric input function (option card)	27: Switch main frequency source to AI1 28: Switch main frequency source to AI2 29: Switch main frequency source to AI3 30: Switch main frequency source to AI4 31: Switch main frequency source to high-	0	★

P06.07	DI7 Numeric input function (option card)	frequency pulse input 32: Switch main frequency source to communication setting 33: Switch auxiliary frequency source to numeric frequency setting 34: Accel and Decel time terminal 1	0	★
P06.08	DI8 Numeric input function (option card)	35: Accel and Decel time termina2 36: Accel and Decel Stop 37: User-defined fault 1 38: User-defined fault 2 39: PID pause 40: PID integral pause	0	★
P06.09	DI9 Numeric input function (option card)	41: PID parameter Switchover 42: PID Positive/negative reaction switch 43: Preset PID terminal 1 44: Preset PID terminal 2 45: PID Main and Auxaliary command switch 46: PID Main and Auxaliary feedback switch	0	★
P06.13	VDI1 Numeric input function (Virtual DI)	47: Simple PLC status reset 48: Simple PLC time stop	0	★
P06.14	VDI2 Numeric input function (Virtual DI)	49: Swing frequency stop 50: Counter 1 input 51: Counter 1 reset/clear 52: Counter 2 input	0	★
P06.15	VDI3 Numeric input function (Virtual DI)	53: Counter 1 reset/clear 54: Clear/reset timed running time 55: Motor 2 Accel and Decel time selection 57: brake feedback input/brake feedback input	0	★
P06.16	VDI4 Numeric input function (Virtual DI)	58: brake release feedback input 64: PID2 pause 65: PID2 integral pause 66: PID2 parameter Switchover 67: PID2 Positive/negative reaction switch 68: Preset PID2 terminal 1 69: Preset PID2 terminal 2 70: 45: PID Main and Auxaliary command switch 71: PID Main and Auxaliary command switch	0	★
P06.17	Virtual input source	Unit'digit: VDI1 input source 0~F: P06.33 specifies the bit0~bit15 of the parameter Ten's digit: VDI2 input source 0~F: P06.34 specifies the bit0~bit15 of the parameter. Hundred's digit: VDI3 input source 0~F: P06.35 specifies the bit0~bit15 of the parameter	0003	★

		Thousand's digit: VDI4 input source 0~F: P06.36 specifies the bit0~bit15 of the parameter		
P06.18	DI Forcing function	Define as per bit :Disable;1:Enable Bit0-bit11:DI1-DI12 Bit12-bit15:VDI1-VDI4 When the bit is enabled, the state of the DI or VDI is set by the corresponding bit of P06.19.	H0000000 0 L00000000	★
P06.19	DI Forcing data	Define as per bit 0:effective;1:ineffective Bit0-bit11:DI1-DI12 Bit12-bit15:VDI1-VDI4	0	☆
P06.20	Effective logic of Numericinput terminal	Define as per bit 0:positive logic;1:negative logic Bit0-bit11:DI1-DI12 Bit12-bit15:VDI1-VDI4 In the reverse logic, the inactive level of the DI terminal becomes the active level.	0	★
P06.21	DI1 Effective delay time	0.000s~30.000s	0.000s	☆
P06.22	DI1 ineffective delay time	0.000s~30.000s	0.000s	☆
P06.23	DI2 Effective delay time	0.000s~30.000s	0.000s	☆
P06.24	DI2 ineffective delay time	0.000s~30.000s	0.000s	☆
P06.25	DI3 Effective delay time	0.000s~30.000s	0.000s	☆
P06.26	DI3 ineffective delay time	0.000s~30.000s	0.000s	☆
P06.27	DI4 Effective delay time	0.000s~30.000s	0.000s	☆
P06.28	DI4 ineffective delay time	0.000s~30.000s	0.000s	☆
P06.29	Two wire/3wire operation control	0: 2-wire mode (FWD+REV)1 1: 2-wire mode RUN+DIRECTION)2 2: 3-wire 1(FWD+REV+ENABLE) 3: 3-wire 2 RUN +FWD/REV+ENABLE	0	★

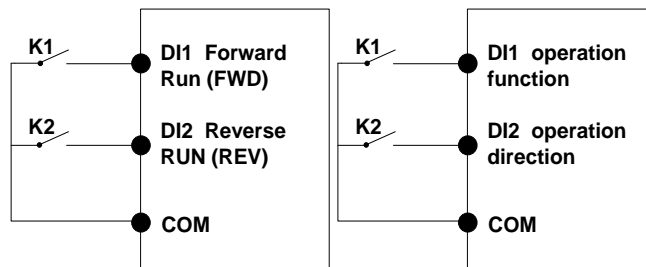

Figure1: Two-line mode 1

Figure 2: Two-line mode2

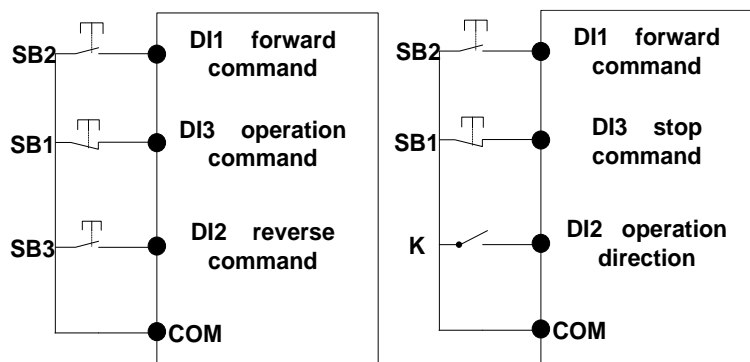

Figure 3: Three-line mode1

Figure 4: Three-line mode2

Two-line mode 1:

K1 is closed, the drive is running forward, K2 closed reverse operation, K1, K2 at the same time closed or disconnected, the inverter stops running.

Two-line mode 2:

In K1 closed state, K2 disconnect the inverter forward, K2 closed inverter reverse; K1 off the inverter to stop running.

Three-line mode 1:

DI3 is set to three-wire control function. When the SB1 button is closed, press the SB2 button. The inverter is forward running. Press the SB3 button to invert the inverter. When the SB1 button is off, the inverter will stop. During normal start-up and running, it is necessary to keep the SB1 button closed, and the commands of SB2 and SB3 buttons take effect during the closing operation. The running status of the inverter takes the last key action of the three buttons as the standard.

Three-line mode 2:

DI3 is set to three-wire control function. When the SB1 button is closed, press the SB2 button to run the inverter, K to switch the inverter forward, K to close the inverter and SB1 to turn off the inverter. During normal start-up and operation, it is necessary to keep the SB1 button closed and the command of the SB2 button effective during the closing operation.

P06.30	Digital input terminal filtering time	0.000~0.100s Set the sample filter time of DI1~DI4 and HDI terminals. If the interference is strong, increase the parameter to avoid wrong operation.	0.010s	☆
P06.31	Terminal protection function	0: no protection When command is terminal ,power on and terminal effective,inverter will run 1: protection When command is terminal ,power on and terminal effective, inverter will not run ,so need terminal ineffective then effective,then inverter will run	0	★
P06.32	DI terminal on/ready time	0.000s~30.000s	1.000s	★
P06.33	VDI1 source	To Select the source of VDI1, Please select the input signal of VDI1 together with the Unit's digit of P06.17.	06.00	★
P06.34	VDI 2 source	To Select the source of VDI2, Please select the input signal of VDI1 together with the Ten's digit of P06.17.	06.00	★
P06.35	VDI 3 source	To Select the source of VDI3, Please select the input signal of VDI1 together with the Hundred's digit of P06.17.	07.00	★
P06.36	VDI 4 source	To Select the source of VDI4, Please select the input signal of VDI1 together with the Thousand's digit of P06.17.	44.00	★
07 Group Multi-function Digital output				
r07.00	DO output port status	Define as per bit, 0:ineffective 1:effective	-	●

		Bit0:DO1 Bit1:D02 Bit2:relay1, Bit 3:relay 2 Bit4: DO3;Bit5: DO4 Bit6: DO5; Bit7: DO6 Bit8: VDO1;Bit9: VDO2		
P07.01	DO1 Output terminal function group	0:No function 1:READY 2:RUN 3:Error1 (All fault 4:Error2 (Stop fault) 5:Error 3 t(fault but It still keeps running) 6:Swing frequency limit 7:Torque limit	0	☆
P07.02	DO2(HDO) Output terminal function group	8:Reverse running 9: Upper limit frequency arrival 10:Lower limit frequency arrival 1 11: Lower limit frequency arrival2 12:FDT1 output frequency detection range 13:FDT2 output frequency detection range 14:Setting frequency arrival	0	☆
P07.03	Relay 1 Output terminal function group(T1A T1B T1C)	15:Desired frequency attained 1 P08.05 16:Desired frequency attained 2P08.07 17:Zero speed (stop without output) 18: Zero speed (stop with output) 19:Zero current status 20:Output current exceed limit	3	☆
P07.04	Relay 2 Output terminal function group(T2A T2B T2C)	21:Counter 1 setting value arrival 22:Counter 1 setting value arrival 23:Simple PLC cycle finish 24:Reserved 25:Drive overload pre-warning 26: Motor overload pre-warning	0	☆
P07.05	DO3 Output terminal function group(IO card)	27: Motor overheat pre-warning 28:Off loading 29:Reserved 30:Reserved 31: Reserved 32:Variable selector unit 1 output	0	☆
P07.06	DO4 Output terminal function group(IO card)	33:Variable selector unit 2 output 34:Variable selector unit 3 output 35:Variable selector unit 4 output 36:Logic unit 1 output 37:Logic unit 2 output 38:Logic unit 3 output	0	☆

P07.07	DO5 Output terminal function group(IO card)	39:Logic unit 4 output 40:Delaying unit 1 output 41:Delaying unit 2 output 42: Delaying unit 3 output 43: Delaying unit 4 output 44: Reserved	0	☆
P07.08	DO6 Output terminal function group(IO card)	45: Reserved 47: Brake control output	0	☆
P07.09	VDO1(virtual DO1) output Terminal function		0	☆
P07.10	VDO2(virtual DO2) output Terminal function		0	☆
P07.11	Output logic negative	Define as per bit 0:off;1:on(negative) Bit0:DO1 Bit1:DO2 Bit2:Relay 1 Bit3: Relay 2 Bit4: DO3;Bit5: DO4 Bit6: DO5; Bit7: DO6 Bit8: VDO1;Bit9: VDO2 Notice:posive logic equivalent to Normal open point And negative logic equivalent to Normal close point	0	☆
P07.12	DO1 effective delay time	0.000s~30.000s	0.000s	☆
P07.13	DO1 ineffective delay time	0.000s~30.000s	0.000s	☆
P07.14	DO2 effective delay time	0.000s~30.000s	0.000s	☆
P07.15	DO2 ineffective delay time	0.000s~30.000s	0.000s	☆
P07.16	Relay 1 effective delay time	0.000s~30.000s	0.000s	☆
P07.17	Relay 1 ineffective delay time	0.000s~30.000s	0.000s	☆
P07.18	Relay 2 effective delay time	0.000s~30.000s	0.000s	☆
P07.19	Relay 2 ineffective delay time	0.000s~30.000s	0.000s	☆

08 Group Digital output setting				
P08.00	Frequency detection value (FDT1)	0.00Hz~maximum frequency(P01.06)	50.00Hz	☆
P08.01	Frequency detection hysteresis 1	0.0%~100.0% FDT1	5.0%	☆
P08.02	Frequency detection value 2(FDT2)	0.00Hz~maximum frequency(P01.06)	50.00Hz	☆
P08.03	Frequency detection hysteresis 2	0.0%~100.0% FDT2(P08.02)	5.0%	☆
<p>FDT is used to check inverter output frequency,when output frequency is greater than frequency detection value,FDT effective,when output frequency is less than frequency detection value*(1- Frequency detection hysteresis),FDT ineffective;whenoutput frequency is between the above two,FDT output keep no change,following is FDT chart</p>				
P08.04	Detection range of frequency arrival	<p>0.0%~100.0% maximum frequency (P01.06)</p> <p>When output frequency is between command frequency $\pm P08.04 * P01.06$,corresponding DO output effective signal</p>	3.0%	☆
P08.05	Desired frequency attained 1	0.00Hz~maximum frequency (P01.06)	50.00Hz	☆
P08.06	Any frequency reaching detection amplitude 1	0.0%~100.0% maximum frequency (P01.06)	3.0%	☆
P08.07	Desired frequency attained2	0.00Hz~maximum frequency(P01.06)	50.00Hz	☆
P08.08	Any frequency reaching detection amplitude 2	0.0%~100.0% maximum frequency (P01.06)	3.0%	☆
<p>When the output frequency reaches positive or negative detection amplitude of frequency detection value, DO outputs ON signal. VFD500 series inverter provides two parameters of any arrival frequency detection value, used to set frequency value and frequency detection range.</p>				

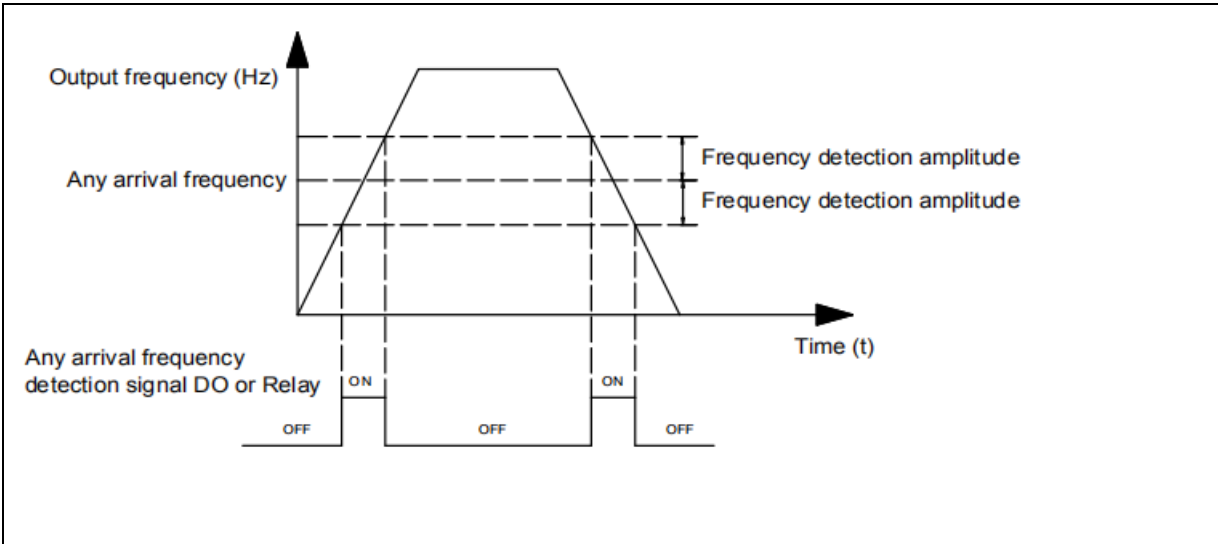

P08.09	Zero speed detection amplitude	0.00H~5.00Hz	0.25Hz	☆
P08.10	Zero current detection level	0.0%~100.0% rated motor current	5.0%	☆
P08.11	Zero current detection delay time	0.000~30.000s 0.000~30.000s Notice: When output current \leq P08.10 and endure P08.11 time, corresponding DO output effective signal	0.100s	☆

When the output current \leq zero current detection level, lasts for longer than zero current detection delay time, DO terminal outputs ON signal.

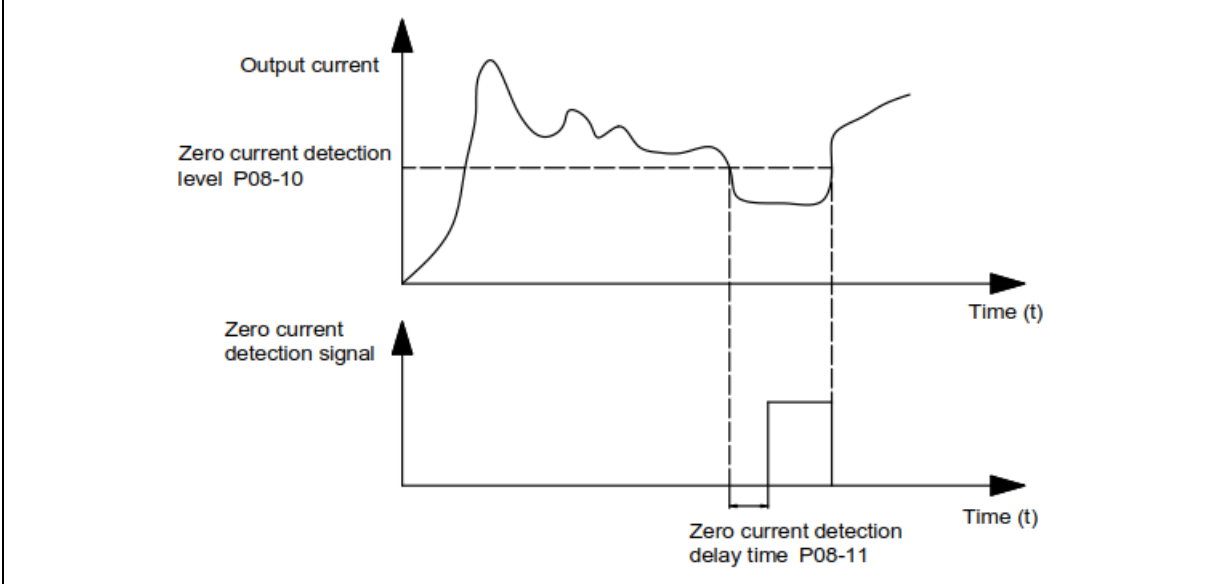

P08.12	Output overcurrent threshold	0.0%~300.0% motor rated time	200.0%	☆
P08.13	Overcurrent detection delay time	0.000~30.000s Notice: When output current \geq P08.12 and endure P08.13 time, corresponding DO output effective signal	0.100s	☆

When the output current is bigger than or over-limit detection point, lasts for longer than software over current point detection delay time, DO terminal outputs ON signal.

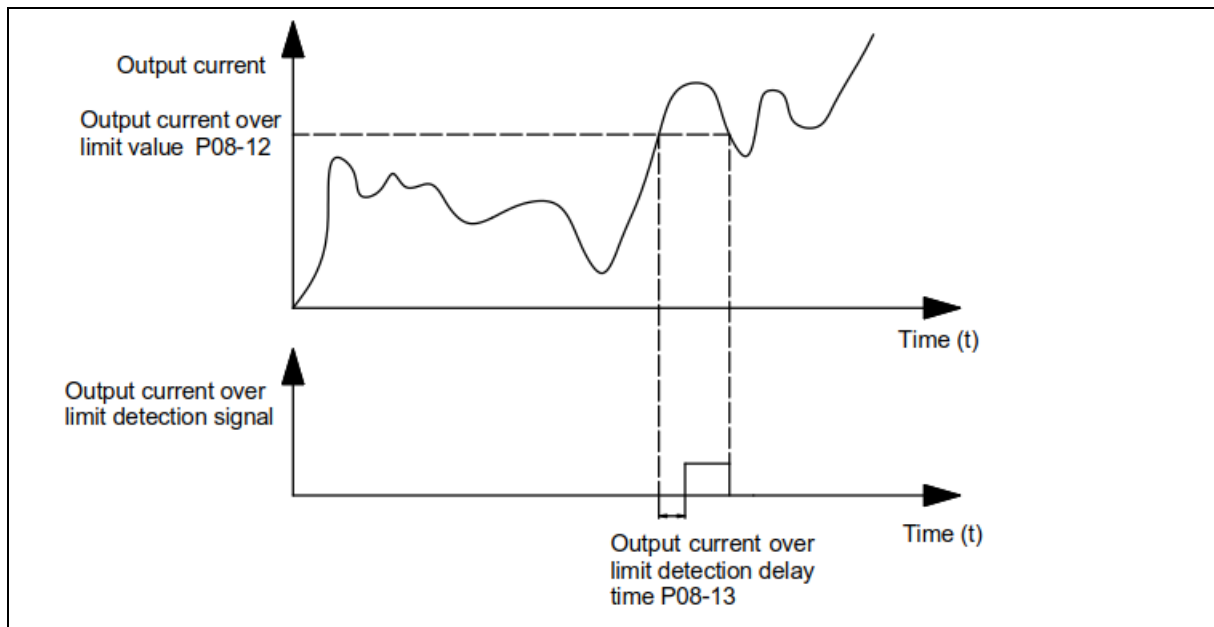

10 Group encoder type				
P10.01	Encoder type	0: ABZ 1: ABZUVW 2: Rotary/resolver 3: sin/cos encoder ➤ Consult factory when need PG card	0	★
P10.02	Encoder line number	1~65535 Rotary pulse number: 1024× rotary pair of poles	1024	★
P10.03	AB pulse direction	0: forward, 1: reverse ➤ If control mode is VC (with PG card)we can get this value by auto tuning for motor ➤ We can run motor with open loop,and observe r10.12 and r27.00 if they are in the same direction,if not,then change this value	0	★
P10.04	UVW Phase	0: forward, 1: reverse This value is generally obtained through encoder self-learning (P11.10=3, 13)	0	
P10.05	Z pulse angle	0.0 ~ 359.9	0.0	
P10.06	UVW angle	0.0 ~ 359.9	0.0	
P10.07	Rotating ratio molecule between motor and encoder	1~65535	1000	★
P10.08	Rotating ratio demonimator between motor and encoder	1~65535	1000	★
<p>When encoder is not installed on the motor rotor axis, asynchronous motor vector control with encoder is effective by setting motor and encoder rotating speed ratio (P10.07 and P10.08)</p> $\text{motor rotating speed} = \frac{P10.07}{P10.08} \times \text{encoder speed}$ <p>For example: if motor rotating speed is 1500RPM and encoder speed 1000RPM, set P10.07=1500, P10.08=1000.</p>				
P10.09	Encoder offline detection time	0.0(not detecting)~10.0s	2.0	★
P10.11	Encoder rotation filter time	0~32 speed loop control cycle	1	★
r10.12	Encoder feedback rotating speed	Current rotating speed by measuring, unit: 0.01Hz/1Rpm ➤ unit set by P21.17。 ➤ no symbolic number, Function code r27.02:Bit5 for direction; keypad indicator 【REV】 indicate direction	-	●
r10.13	Encoder current position	0 ~ 4*encoder pulse number -1 encoder current position refer Z pulse as zero point,motor forward running and one cyle to Z pulse ,then postion to zero	-	●

r10.14	Z pulse marking value	0 ~ 4*encoder pulse number-1 (it is used to monitor encoder slipping and AB being disturbed)	-	•
r10.15	UVW status	It is used to monitor the current UVW level of ABZUVW encoder.	-	•

11 Group Motor 1 Parameter				
P11.00	Motor type	0: AC asynchronous motor 1: Synchronous motor	0	•
P11.02	Motor rated power	0.1kW~800.0kW ➤ when power is less than 1kw ,0.75kw set to 0.8 as per round up principle ,0.55kw motor set 0.6 ➤ when change motor rated power,AC drive will automatically set other parameter of motor name plate and motor model parameter be careful to use	Depend	★
P11.03	Motor rated voltage	10V~2000V	Depend	★
P11.04	Motor rated current	P11.02<30kW: 0.01A P11.02>=30kW: 0.1A	Depend	★
P11.05	Motor rated frequency	1.00Hz~600.00Hz	50.00Hz	★
P11.06	Motor rated RPM	1~60000rpm	Depend	★
P11.07	Motor rated power factor	0.500~1.000	Depend	★
r11.08	Motor rated torque	Read only,0.1Nm(P11.02<30KW); 1Nm(P11.02>30KW)	-	•
r11.09	Number of motor 1 pairs of pole	Read only,It will auto calculate as per motor rated frequency and rated rotating speed	-	•
P11.10	Auto-tune/self-learning	Unit'digit 0: no auto tuning 1: Stationary auto tuning of Asynchronous motor It is suitable in the cases when the motor can not de-couple form the load. The auto tuning for the motor parameter will impact the control accuracy. 2: Dynamic or Rotational auto tuning of Asynchronous motor Comprehensive motor parameter autotune It is recommended to use rotation auto tuning when high control accuracy is needed. 3: Encoder self-learning Ten'digit : load type during self-learning 0: No load or light load 1: Heavy load or with brake	00	★
<p>1: Stationary auto tuning of Asynchronous motor During self-learning, the motor shaft may rotate half a circle at most. After static self-learning, asynchronous motors can learn parameters P11.11 to P11.13, synchronous motors can learn parameters P11.19 to P11.21, and synchronous motors cannot be learned The back EMF.</p> <p>2: Rotatoinal auto tuning of Asynchronous motor During self-learning, the motor first stops and then rotates. After the self-learning is completed, the asynchronous motor can obtain parameters P11.11~P11.18. For closed-loop vector control, the encoder direction P10.03 can also be obtained, and the synchronous motor can obtain P11.19 ~ P11.22 When rotating self-learning, the motor will rotate forward and the speed can reach 50% ~ 100% of the rated</p>				

speed.

Before rotating self-learning, please make sure that the back-EMF (P11.22) of the synchronous motor is within $\pm 20\%$ of the actual value.

3 Encoder self-learning

When the ten's digit is set to 0, the motor rotates slowly and can learn from P10.03 ~ P10.06.

When the tens place is set to 1, only P10.04 ~ P10.06 can be learned (P10.03 needs to be manually input, which can be determined by observing whether r10.12 is in the same direction with the running frequency through open loop operation).

Under normal circumstances, the results of the encoder's no-load self-learning are more accurate than the results of the brake or heavy-load learning;

Please execute motor self-learning before executing encoder self-learning! Encoder load self-learning must be carried out in closed-loop vector control mode!

Asynchronous machine does not need to perform encoder self-learning!

Notice:

Please confirm that the motor nameplate parameters (P11.00 ~ P11.06) have been set correctly before the motor self-learning, and the encoder parameters (P10.01 ~ P10.02) should be set correctly before the encoder self-learning!

it can do motor auto tune when command source is keypad only(P00.06=0)

After setting this parameter, press the "RUN" button on the keyboard, the self-learning will start, and the inverter will stop itself after the self-learning is completed.

P11.11	Stator resistor of Asynchronous motor	Unit:0.001 Ω (P11.02<30kW) Unit:0.01m Ω (P11.02 \geq 30kW)	Depend	★
P11.12	Rotor resistor of Asynchronous motor	Unit:0.001 Ω (P11.02<30kW) Unit:0.01m Ω (P11.02 \geq 30kW)	Depend	★
P11.13	Leakage inductance of Asynchronous motor	Unit:0.01mH(P11.02<30kW) Unit:0.001mH(P11.02 \geq 30kW)	Depend	★
P11.14	Mutual inductance of Asynchronous motor	Unit:0.1mH(P11.02<30kW) Unit:0.01mH(P11.02 \geq 30kW)	Depend	★
P11.15	No-load excitation current of Asynchronous motor	Unit:0.01A(P11.02<30kW) Unit:0.1A(P11.02 \geq 30kW)	Depend	★
P11.16	Excitation saturation factor 1	At non rated-excitation status	1.100	★
P11.17	Excitation saturation factor 2	At non rated-excitation status	0.900	★
P11.18	Excitation saturation factor3	At non rated-excitation status	0.800	★
P11.19	Stator resistor of synchronous motor	Unit:0.001 Ω (P11.02<30kW) Unit:0.01m Ω (P11.02 \geq 30kW)	Depend	★
P11.20	Synchronous motor d-axis inductance	Unit:0.001 Ω (P11.02<30kW) Unit:0.01m Ω (P11.02 \geq 30kW)	Depend	★
P11.21	Synchronous motor q-axis inductance	Unit:0.01mH(P11.02<30kW) Unit:0.001mH(P11.02 \geq 30kW)	Depend	★
P11.22	Synchronous motor back electromotive force BEMF	0.0V ~ 2000.0V Induced electromotive force at rated speed	Depend	★

12 Group Motor 1 VF control parameter

P12.00	VF curve	0: linear VF 1: Multi-point VF 2: VF to the 1.3 3: 1.7 power 4: 2.0 power 5: VF complete separation 6: VF Half separation	0	★
--------	----------	---	---	---

➤ When the VF curve is straight line and power curve, the frequency-voltage curve is as follows:

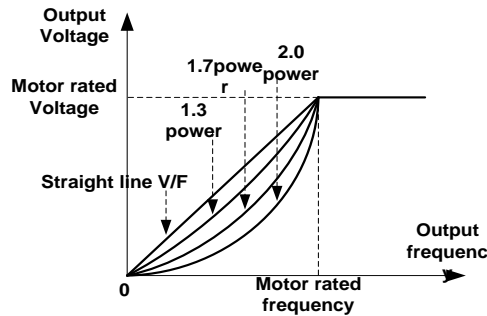

Figure 1: Straight line VF and 1.3、1.7、2.0 power VF

➤ Multi-stage line type VF curve:

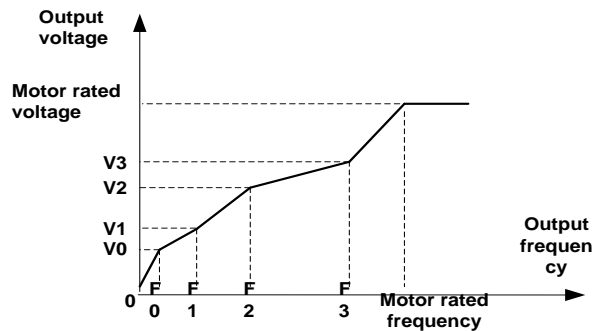

Figure 2: multi-stage line type VF curve

➤ VF full separation

The output voltage and output frequency are completely independent. The output frequency is determined by the frequency source. The output voltage is determined by P12.20. Suitable for applications such as variable frequency power or torque motors.

➤ VF semi-isolated

At this point the ratio of output voltage and output frequency given by the voltage source, the formula is as follows:

$$\text{output voltage} = 2 \times \text{Voltage source given} \times \text{output frequency} \times \frac{\text{motor rated voltage}}{\text{motor rated frequency}}$$

P12.01	Multi-point VF Frequency 1(F0)	0.00Hz~multi-point VF curve F1(P12.03)	0.00Hz	☆
P12.02	Multi-point VF Voltage 0(V0)	0.0%~100.0%	0.0%	☆
P12.03	Multi-point VF Frequency 1(F1)	multi-point VF curve F0(P12.01)~multi-point VF curve F2(P12.05)	50.00Hz	☆
P12.04	Multi-point VF Voltage 1(V1)	0.0%~100.0%	100.0%	☆

P12.05	Multi-point VF Frequency 1(F2)	multi-point VF curve F1(P12.03)~multi-point VF curve F3(P12.08)	50.00Hz	☆
P12.06	Multi-point VF Voltage 2(V2)	0.0%~100.0%	100.0%	☆
P12.07	Multi-point VF Frequency 3(F3)	multi-point VF curveF2(P12.05)~600.00Hz	50.00Hz	☆
P12.08	Multi-point VFFoltage 3(V3)	0.0%~100.0%	100.0%	☆
P12.09	Torque boost	0%~200% 0% is automatic torque boost	0%	☆
<p>➤ Automatic torque boost</p> <p>When P12.09=0=Automatic torque boost,inverter will automatically compensate output voltage to improve torque in low frequency as per actual load ,it is useful for linear VF curve</p> <p>➤ Manual torque boost</p> <p>➤ When P12.09 not 0,it means manual torque output.Output frequency 0 torque increasing value=p12.09*motor stator resistance *rated excitation current,,increasing value will be gradully decreased as frequency increase ,if higher than 50% of motor rated frequency,increasing value will be zero</p> <p>➤ Notice>manual torque boost is useful to linear and power curve</p>				
P12.11	Slip compensation gain	0~200% It is used to compensate the speed drop of the asynchronous motor VF control with load, and improve the speed control accuracy. Please adjust according to the following principles: <ul style="list-style-type: none"> ● Increase the setting when the motor speed is lower than the target value with loading. ● Reduce this setting when the motor speed is higher than the target value with loading, 	100%	☆
P12.12	Slip compensation filter time	0.01s~10.00s It is used to adjust the speed and stability of the VF control response to the load. <ul style="list-style-type: none"> ● Decrease this setting when the load response is slow. ● Increase this setting when the speed is unstable 	1.00s	☆
P12.13	Oscillation suppression gains	0~2000 In the SVPWM control mode, current fluctuation may occur to the motor on some frequency, especially the motor with big power. The motor can not run stably or overcurrent may occur. These phenomena can be canceled by adjusting thisparameter.	300	☆
P12.14	Oscillation suppression effective frequency range	Oscillation suppression effective range :100%~1200% Set the range of the oscillation suppression function, 100% corresponds to the rated	110%	☆

		frequency of the motor		
P12.15	Current limit function selection	0: ineffective 1: only adjust output voltage(Current limiting for general VF separation) 2: adjust output frequency	2	★
P12.16	Current limit level	20%~180% drive rated current	150%	☆
P12.17	Weak magnetic zone current limit factor	optimize dynamic performance of Weak magnetic zone,10%~100%	0.60	☆
P12.20	Voltage source for VF separation	0: digital setting 1: AI1 2: AI2 3: AI3(IO expansion board) 4: AI4(IO expansion board) 5: HDI 6: Reserved 7: communication 8: PID	0	★
P12.21	Digital setting for VF separation voltage	0.0%~100.0%	0.0%	☆
P12.22	VF separation voltage Accel and Decel time	0.00s~60.00s	1.00s	☆
P12.23	VF Separation voltage rates as per time	VF Separation Voltage variation every hour range:-100.00%~100.00%	0.0%	☆
P12.36	Synchronous motor no-load current 0	1.0% ~ 100.0%	30.0%	☆
P12.37	Synchronous motor no-load current 1	1.0% ~ 100.0%	15.0%	☆
P12.38	Synchronous motor no-load current 2	1.0% ~ 100.0%	10.0%	☆
P12.39	High efficiency control time constant	0.00s~10.00s It is used to reduce the input current of the synchronous motor with load to improve its operating efficiency. Generally, the greater the load inertia, the greater the set value, and the set value can also be adjusted according to the following rules: When the motor speed fluctuates greatly, the set value can be appropriately increased; When the torque response is slow, the setting value can be appropriately reduced.	1.00s	☆
P12.41	Back EMF Compensation amount	0%~100% When the low frequency torque is insufficient, this setting value can be appropriately increased.	20%	☆
P12.42	Back EMF compensation cutoff frequency	1.0%~100% After the value is higher than this setting, the back-EMF compensation will be cancelled.	50.0%	☆
P12.43	Voltage drop compensation	0%~100%	50%	☆

	gain			
P12.44	Pressure drop compensation time	0.001s~1.000s	0.010s	☆

13 Group Motor 1 vector control				
P13.00	Speed Proportional Gain ASR_P1	0.1~100.0	12.0	☆
P13.01	Speed Integral Time constant ASR_T1	0.001s~30.000s	0.200s	☆
P13.02	Speed Proportional Gain ASR_P2	0.1~100.0	10.0	☆
P13.03	Speed Integral Time constant ASR_T1	0.001s~30.000s	0.500s	☆
P13.04	ASR parameter Switching frequency 1	0.00Hz~ ASR switching frequency 2(P13.05)	5.00Hz	☆
P13.05	ASR parameter Switching frequency 2	ASR switching frequency 1~600.00Hz(P13.04)	10.00Hz	☆
<p>By setting the speed factor and integration time of the speed regulator, you can adjust Section vector controlled speed loop dynamic response characteristics. Increase the proportional gain and reduce</p> <p>The integration time can speed up the dynamic response of the speed loop, but the proportional gain is too large</p> <p>Or the integration time is too small, it is easy to cause the system to oscillate, and the overshoot is too large.</p> <p>Proportion increase</p> <p>Too small is also likely to cause steady-state oscillations of the system, and there may be a speed difference.</p> <p>PI parameter</p> <p>PI has a close relationship with the inertia of the system. Adjust on the base of PI according to different loads to meet various demands.</p> <p>P13.00 and P13.01 are Speed adjuster parameter for low-speed use,scope of action from zero to P13.04</p> <p>P13.02 and P13.03 are Speed adjuster parameter for high-speed use,scope of action from P13.05 to maximum frequency</p> <p>P13.04-P13.05 Two sets of parameter for linear tansitions</p>				
P13.06	Speed control torque limit source selection	Unit's digit: Electric torque limit source 0:Digital setting 1:AI1 2:AI2 3:AI3((IO expansion board) 4:AI4(IO expansion board) 5: HDI 6:Communication	00	★

		Ten'unit: Electric torque limit source Same as unit'digit		
P13.07	Electric torque limit	0.0%~300.0%	160.0%	☆
P13.08	Upper limit of brake torque	0.0%~300.0%	160.0%	☆
P13.09	Power limit enable	Units: Electric power limit selection 0: Disable 1: enable Ten's place: Braking power limit selection 0: Disable 1: enable	00	★
P13.10	Electric power limit	0.0%~300.0%	200.0%	☆
P13.11	Braking power limit	0.0%~300.0%	200.0%	☆
P13.12	Torque current directives filter time	Unit: current loop adjust cycle ,0~100	2	☆
P13.13	ACR Proportional Gain1	0.01~1000	300	☆
P13.14	ACR Integral Time1	0.01~300.00ms	10.00ms	☆
P13.15	ACR Proportional Gain2	0.01~1000	300	☆
P13.16	ACR Integral Time2	0.01~300.00ms	10.00ms	☆
<p>ACR: Automatic current regulator. ACR parameters adjust the PI adjustment parameter of the current loop which affects the dynamic response speed and control accuracy directly. Generally, users do not need to change the default value; Only apply to the vector control mode without PG card (P00.04=0).</p>				
P13.17	Voltage feedforward Gain	0~100improve the dynamic response of vector control,	0	★
P13.19	Voltage margin	0.0%~50.0%improve the dynamic response of weak magnetic curvature.	3.0%	☆
P13.20	Field weakening regulator integration time	0.001s-5.000s	0.01s	☆
P13.21	Proportional gain of field weakening regulator	0.000~2.000	0.100	☆
P13.22	Slip compensation	50%-200% For sensorless vector control, this parameter is used to adjust the speed stabilizing precision of the motor. When the speed is too low due to heavy load of motor, this parameter needs to be enlarged, vice versa.	100%	☆
P13.23	SVC zero speed directives	0:No action 1:Output DC current	0	★

14 Group Torque control				
P14.00	Torque control input source	0: Digital setting(P14.01) 1: AI1 2: AI2 3: AI3(IO expansion board) 4: AI4(IO expansion board) 5: HDI 6: Communication	0	★
P14.01	Torque digital setting	-200.0~200.0% The torque reference greater than 0 indicates that the direction of the torque is the same as the forward direction of the motor; less than 0 indicates that the direction of the torque is the same as the reverse direction of the motor.	0	☆
P14.02	Maximum torque	Benchmark 10.0%~300.0% Notice:It is torque benchmarks as torque reference for analog inputs and high frequency pulse input also it is the ultimate output torque during torque control.	200.0%	★
P14.03	Torque Acceleration time	0.000s~60.000s Notice:Torque reference time from zero to motor rated torque	0.100s	☆
P14.04	Torque control Deceleration time	0.000s~60.000s Notice:Torque given time from motor rated torque to zero	0.100s	☆
P14.05	Speed limit source	Units: speed limit source selection 0: Digital setting (P14.06) 1: AI1 2: AI2 3: AI3 (expansion card) 4: AI4 (expansion card) 5: HDI 6: Communication Ten's place: speed limit source symbol 0: unsigned 1: Signed	0	★
P14.06	Digital setting of forward speed limit value	Relative to the maximum frequency: 0.00%~100.00%	100.0%	☆
P14.07	Digital setting of reverse speed limit value	Relative to maximum frequency: 0.0%~100.0%	100.0%	☆
P14.08	Torque setting over limit speed	0: Symmetrical torque command After the motor speed exceeds the speed limit value, the torque input source sets the absolute value of the torque reference, and the direction of the torque is always the braking force. 1: Enter speed mode After the motor speed exceeds the speed limit	0	★

		value, enter the speed mode, and the inverter will limit the speed to within the speed limit value as much as possible.		
P14.10	Static friction torque	0.0%~50.0%	10.0%	☆
P14.11	Static friction torque compensation	0.00Hz~50.00Hz It is used to overcome the static friction force at the start, and the speed is higher than P14.11 and the static friction torque compensation is cancelled.	1.00Hz	★
P14.12	Dynamic friction factor	0.0%~50.0% Dynamic friction at rated speed Notice: motor sliding friction torque at rated rotating speed	0.0%	☆
P14.13	Dynamic friction starting value	0.0%~50.0%	0.0%	☆
P14.14	Filter coefficient	0~1000	50	☆
P14.15	Torque control upper limit frequency acceleration time	0.00~655.35	0.00	☆
P14.16	Torque control upper limit frequency deceleration time	0.00~655.35	0.00	☆

16 Group Energy saving control

r16.00	Electricity meter count (32BIT)	Unit:KW/H	-	●
r16.02	Output power	Unit:0.1kw,output power will be negative in regen state	-	●
r16.03	Power factor	-1.000~1.000	-	●
P16.04	Electricity meter zero clearing	0:no function; 1111: clear to zero	0	☆
P16.05	Energy saving control	0: disable 1: enable	0	★
P16.06	Energy saving voltage limit	0%~50%(0% means Energy saving control disable and more than 0% means Energy saving control enable)	0%	☆
P16.07	Energy saving filter time	0.0~10.0s	2.0s	☆

Notice:P16.05 is invisible(it is useful in vf control) and When energysaving enabled, the output current can be reduced and the power loss can be reduced when the load is light.For example, the fan and pump is light loaded, most of the inverters do not have this function, so

we are more energy efficient. Energy savings can be achieved when it is light loads or load changes so slow

17 Group synchronous motor control

P17.00	Initial position identification mode	0: Pulse testing 1: High frequency injection	1	★
P17.01	Initial position identification current	50% ~ 180%	100%	★
P17.03	Low speed zone definition	0.1% ~ 60.0%	10.0%	★
P17.07	High frequency injection amplitude	5% ~ 50.0% For the amplitude of high-frequency signal injection, the larger the set value, the higher the accuracy of position identification, but the greater the noise of the motor. The set value should be as small as possible when the accuracy meets the requirements.	20.0%	☆
P17.11	Operation mode in low speed in SVC	0: normal way 1: High frequency injection operation	0	★
P17.12	No load current in low speed in SVC	0.0% ~ 100.0%	20%	☆
P17.13	No load current in high speed in SVC	0.0% ~ 50.0%	2.0%	☆
P17.18	MTPA control	0:disable 1:enable MTPA is the maximum torque current ratio control. Enabling MTPA can reduce the motor current when SVC and VC are running under load.	0	☆
P17.19	MTPA control adjust time	The smaller the set value, the faster the MTPA will act, it will cause current oscillation if set value too small	0.500	☆

20 Group User-defined function code menu				
P20.00	User-defined function code 0	<p>The value is the function code number, ranging from 00.00 to 63.99.</p> <p>Example: If you want to display P03.01 and P13.00 in the user-defined menu mode (-USr-), set P20.00=03.01, P20.01=13.00</p>	00.00	☆
P20.01	User-defined function code 1		00.00	☆
P20.02	User-defined function code 2		00.00	☆
P20.03	User-defined function code 3		00.00	☆
P20.04	User-defined function code 4		00.00	☆
P20.05	User-defined function code 5		00.00	☆
P20.06	User-defined function code 6		00.00	☆
P20.07	User-defined function code 7		00.00	☆
P20.08	User-defined function code 8		00.00	☆
P20.09	User-defined function code 9		00.00	☆
P20.10	User-defined function code 10		00.00	☆
P20.11	User-defined function code 11		00.00	☆
P20.12	User-defined function code 12		00.00	☆
P20.13	User-defined function code 13		00.00	☆
P20.14	User-defined function code 14		00.00	☆
P20.15	User-defined function code 15		00.00	☆
P20.16	User-defined function code 16		00.00	☆
P20.17	User-defined function code 17		00.00	☆
P20.18	User-defined function code 18		00.00	☆
P20.19	User-defined function code 19		00.00	☆
P20.20	User-defined function code 20		00.00	☆
P20.21	User-defined function code 21	00.00	☆	

P20.22	User-defined function code 22		00.00	☆
P20.23	User-defined function code 23		00.00	☆
P20.24	User-defined function code 24		00.00	☆
P20.25	User-defined function code 25		00.00	☆
P20.26	User-defined function code 26		00.00	☆
P20.27	User-defined function code 27		00.00	☆
P20.28	User-defined function code 28		00.00	☆
P20.29	User-defined function code 29		00.00	☆
P20.30	User-defined function code 30	<p>The value is the function code number, ranging from 00.00 to 63.99.</p> <p>Example: If you want to display P03.01 and P13.00 in the user-defined menu mode (- USr-), set P20.00=03.01, P20.01=13.00</p>	00.00	☆
P20.31	User-defined function code 31		00.00	☆
P20.32	User-defined function code 32		00.00	☆
P20.33	User-defined function code 33		00.00	☆
P20.34	User-defined function code 34		00.00	☆
P20.35	User-defined function code 35		00.00	☆
P20.36	User-defined function code 36		00.00	☆
P20.37	User-defined function code 37		00.00	☆
P20.38	User-defined function code 38		00.00	☆
P20.38	User-defined function code 39		00.00	☆
P20.39	User-defined function code 39		00.00	☆

21 Group Keypad and Display Group				
P21.00	Keyboard UP/DOWN function	Units: UP/DOWN enable selection 0: Disable 1: Enable Ten'unit: clear selection 0: Cleared in non-operational state 1: Not cleared Hundred's unit: Power-down memory selection 0: no memory 1: memory Thousand's unit: rate selection 0: automatic rate 1: P01.39 rate	0111	★
P21.02	MK function option	0: no function; 1: Forward Jog 2: Reverse Jog; 3: Forward/reverse Switch 4: Quick stop; 5: coast to stop 6: Curse left shift(LCD keypad)	1	★
P21.03	STOP function	0:Valid only at Keypad Control 1:valid at all command Channels	1	☆
P21.04	Monitoring display1	00.00~99.99	27.00	☆
P21.05	Monitoring display2	00.00~99.99	27.01	☆
P21.06	Monitoring display3	00.00~99.99	27.06	☆
P21.07	Monitoring display4	00.00~99.99	27.05	☆
P21.08	Monitoring display5	00.00~99.99	27.03	☆
P21.09	Monitoring display6	00.00~99.99	27.08	☆
P21.10	Monitoring display7	00.00~99.99	06.00	☆
P21.11	Running status Monitoring display parameter option	Unit'digit to Thousand'digit set 1-4 monitor parameter 0 means no display, 1~7 corresponds to monitor parameter 1~7 Unit' digit: choose first monitoring data, 0~7 Ten's digit: choose second monitoring data, 0~7 Hundred's digit: choose third monitoring data, 0~7 Thousand's digit: choose fourth monitoring display, 0~7	5321	☆
P21.22	Stop status Monitoring display parameter option	Same as P21.11	0052	☆
<p>VFD530 digital keyboard monitoring interface supports up to 4 monitoring volume. Monitoring variables in running status and monitoring variables in stop status are set by P21.11 and P21.12, respectively. Press 【SHIFT】 key on the keyboard to switch the monitoring volume from low to high of P21.11 or P21.12, Encountered "0" then skip, cycle monitoring.</p> <p>Take the shutdown monitoring interface for example, P21.12 = 0052, there are 2 monitoring variables, which are r27.01 (monitor display parameter 2, P21.05 = 27.01) and r27.03 (monitor display parameter 5, P21.08 =</p>				

27.03), press the 【SHIFT】 key on the keyboard to switch between the two monitors, as shown below.

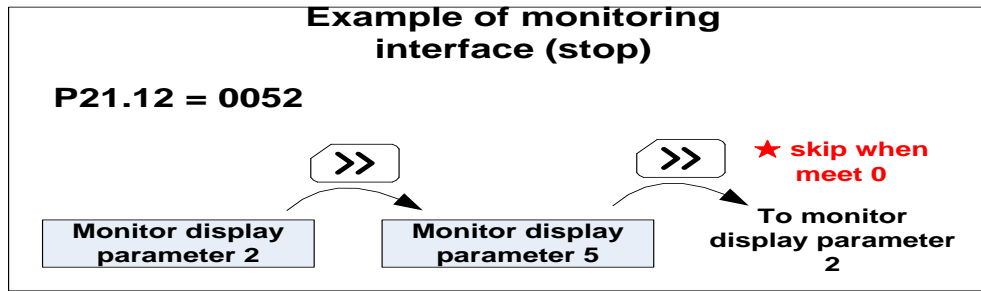

The rules for running the monitoring interface are the same as the shutdown monitoring interface, and will not be repeated

P21.13	Digital keypad personalized setting	<p>Unit's digit: quick editing function selection</p> <p>0: invalid</p> <p>1: Numeric frequency setting 2: Numeric torque setting 3: PID digital setting 0</p> <p>Note: The quick editing function means that if the current monitoring value is the output frequency or command frequency under the monitoring status, press the [ENTER] key to enter the parameter editing interface directly. The edited parameters are set by the ones digit of this function code.</p> <p>Ten's digit: monitor pointer reset selection</p> <p>0: When the display status is in the monitoring status from other status, or when the running monitoring status and stop monitoring status are switched, the previously recorded monitoring pointer position will be restored.</p> <p>1: When the display status is in the monitoring status by other status, or when the monitoring status of running status and stop status are switched, the monitor pointer will be reset to the ones of P21.11 or P21.12.</p> <p>Note: when power-on, the shutdown monitoring pointer points to the P21.12 bits, the operation monitoring pointer points to P21.11 bits</p>	01	★
P21.14	Load speed display factor	0.001~65.000	30.000	☆
P21.15	Load speed decimal point digit	0~3	0	☆
r21.16	Load speed display	Load speed =P27.00*P21.10 Decimal point digit defined by P21.11	-	•
P21.17	Speed display unit	0: 0.01Hz; 1: 1Rpm ➤ Display unit for selecting P00.07, r27.00, r27.01, r10.12	0	★

22 Group AC drive data and configuration				
P22.00	Carrier/switching frequency	<p>Depend on drives power</p> <p>≤7.5kW: 1kHz~12.0kHz</p> <p>11kW~45kW: 1kHz~8kHz</p> <p>≥55kw: 1kHz~4kHz</p> <p>The carrier frequency can be reduced when it came like following phenomenon:</p> <p>1 The leakage current generated by the inverter is large</p> <p>2 The interference generated by the inverter has an impact on peripheral devices</p> <p>3 Long wiring distance between inverter and motor</p> <p>The carrier frequency can be increased whenwhen it came like following phenomenon:</p> <p>1 The electromagnetic noise generated by the motor is large</p>	Depend	☆
<p>Carrier frequency will affect the noise of motor and the EMI of inverter.</p> <p>If the carrier frequency is increased, it will cause better current wave, less harmonic current and lower noise of motor.</p> <p>Notice:</p> <p>The factory default is optimal in most cases. Modification of this parameter is not recommended.</p> <p>If the carrier frequency exceeds the factory default, the inverter must be derated because the higher carrier frequency will cause more switching loss, higher temperature rise of inverter and stronger electromagnetic interference.</p> <p>If the carrier frequency is lower than the factory default, it is possible to cause less output torque of motor and more harmonic current.</p>				
P22.01	Carrier frequency adjustment	<p>Unit'digit: adjustment as per Rotation</p> <p>0:No; 1:Yes</p> <p>Ten'digit: adjustment as per Temperature</p> <p>0 no; 1: yes</p> <p>The inverter can automatically adjust the carrier frequency according to its temperature. This function can reduce the possibility of overheat alarm of the inverter.</p>	00	★
P22.02	Low speed carrier frequency	1.0kHz~15.0kHz	Depend	☆
P22.03	High speed carrier frequency	1.0kHz~15.0kHz	Depend	☆
P22.04	Carrier frequency switching point 1	0.00Hz~600.00HzWhen the carrier frequency is adjusted according to the output frequency, the carrier frequency set by P22.02 is used when the output frequency is lower than this set value.	10.00Hz	☆

P22.05	Carrier frequency switching point2	0.00Hz~600.00Hz When the carrier frequency is adjusted according to the output frequency, the carrier frequency set by P22.03 is used when the output frequency is higher than this set value.	50.00Hz	☆
P22.06	PWM modulation method	0: SVPWM It is normally used 1: SVPWM+DPWM Using this modulation method can reduce the switching loss of the inverter and reduce the probability of overheating alarm of the inverter; however, the electromagnetic noise of the motor in the medium speed section will be too large. 2: PWM at random The electromagnetic noise generated by the motor is white noise, not a sharp squeak. 3: SPWM It is only used in special situation	0	★
P22.07	DPWM switching point	10%~100%(modulation percentage) When P22.06 is set to 1, increasing this setting vaule can reduce the electromagnetic noise in the middle speed section.	30%	★
P22.08	Modulating limit	100-110% It is used to define the duty cycle of the inverter side IGBT. Overmodulation is allowed when it is set to 100% or more, and the allowable overmodulation is deepened when the set value is increased from 101 to 110.	105%	★
P22.10	AVR function	0:disabled 1:enabled When the AVR function is enabled, the effect of the DC bus voltage change on the output voltage can be eliminated.	1	★
P22.11	Energy braking voltage funtion	0-Disabled 1-Enabled 2-only enable when ramp to stop This parameter is only used to control the built-in brake unit. For models without a built-in brake unit, this setting can be ignored.	1	☆
P22.12	Energy braking voltage	320V~400V(220V level) 600V~800V(380V level) 690V~900V(480V level) 950V~1250V(690V level)	Depend	☆
P22.13	Output phase switch	0:No Operation 1:Output phase switch (equal to change Phase between V and	0	★

		W,For closed loop control, you need to re-rotate the self-learning to confirm the encoder direction)		
P22.14	Cooling method (fan control)	0:Effective when running 1:Forced control(effective when power on) 2:Adjustable as per drive temperature	0	☆
P22.15	G/P drive type	0-G type;1-P type ➤ G means normal duty (constant torque load) ➤ P means light duty such as fan and pump	0	★
r22.16	Drive rated power	Read only Unit:0.1kw	-	●
r22.17	Drive rated Voltage	Read only Unit:V	-	●
r22.18	Drive rated current	Read only Unit:0.1A	-	●
P22.20	Trial time setting	After this time, the inverter will stop and report Er.TTA fault; if set to 0, it will be cancelled. Note: This parameter needs agency authority to be able to see	0	☆

23 Group Drive protection function setting				
P23.00	DC Bus voltage control option	<ul style="list-style-type: none"> ➤ Unit'digit :Overvoltage stall control 0:overvoltage stall disabled 1:overvoltage stall enabled 2:overvoltage stall enabled self-adjustable ➤ The over-voltage stall function limits the amount of power generated by the motor by extending the deceleration time or even increasing the speed, avoiding over-voltage on the DC side and reporting over-voltage faults Ten'unit:Undervoltage stall control 0:undervoltage stall disabled 1:Undervoltage stall(decelerate to zero speed and be in standby mode,after power restoring ,it will run again automatically) 2: Undervoltage stall deceleration(decelerate to zero and stop) ➤ The undervoltage stall function reduces the motor power consumption or reduces the power consumption of the motor or turns it into a power generation operation to avoid the undervoltage fault on the DC side. ➤ The undervoltage stall function is used when the input power supply quality is poor (the power supply voltage fluctuates downward or the sporadic short power is suspended), and it is necessary to keep the inverter running as much as possible. 	01	★
P23.01	Overvoltage stall threshold	220V Level: 320V~400V 380V Level: 540V~800V 480V Level: 650V~950V	Depend	★
P23.02	Undervoltage threshold	220V level: 160V~300V 380V level: 350V~520V 480V level: 400V~650V	Depend	★
P23.03	Overvoltage stall ratio	0~10.0	1.0	☆
P23.04	Undervoltage stall ratio	0~20.0	4.0	☆
P23.05	Undervoltage trip threshold	220V Level:160V~300V 380V Level:350V~520V 480V Level:400V~650V	Depend	★
P23.06	Undervoltage fault detecting time	0.0s~30.0s	1.0s	☆
P23.07	Hardware protection configuration	Unit's digit: Wave-by-wave current limit enable 0: invalid; 1: valid Ten's digit short to ground enable bit 0: invalid; 1: valid	11	★
P23.10	Over-speed detection	0.0%~120.0% maximum frequency	120.0%	☆

	value			
P23.11	Over-speed detection time	0.0s~30.0s0.: shielding	1.0s	☆
P23.12	Detection value of too large speed deviation	0.0%~100.0%(motor rated frequency)	20.0%	☆
P23.13	Detection value of too large speed deviation	0.0s~30.0s 0.0: shielding	0.0s	☆
P23.14	Input phase loss detection time	0.0s~30.0s 0.0: forbidden	8.0s	☆
P23.15	Output phase loss inbalance detecting	0%~100%	25%	☆
P23.18	Fault protection action selection 1	Unit's digit : input phase loss 0: coast to stop 1: Emergent stop 2: Stop as per stop mode 3: Continue to Run Ten'unit: user self-defined fault 1 same as Unit's digit Hundred'unit: user self-defined fault 2 same as Unit'digit Thousand's unit: communication fault same as unit's digit	0000	☆
P23.19	Fault protection action selection 2	Unit's digit: motor overload 0: Coast to stop 1: Emergent stop 2: Stop as per stop mode 3: Continue to run Ten'unit: motor overheat same as unit'digit Hundred'unit: too large speed deviation same as unit'digit Thousand's unit: motor over speed same as Unit'digit	0000	☆
P23.20	Fault protection action selection 3	Unit'digit: PID feedback lost 0: Free parking 1: Emergency stop 2: Stop according to the stop mode 3: Keep running Ten's unit: brake slip hook 0: Free parking 1: Emergency stop 2: Stop according to the stop mode 3: Keep running Hundreds/thousands: reserved	0030	☆
P23.21	Fault protection action selection 4	Unit's digit: output phase loss 0: Coast to stop 1: Fast stop	0000	☆

		<p>2: Stop as per stop mode Ten'unit: EEPROM fault 0: Coast to stop 1: Fast stop 2: Stop as per stop mode 3: Continue to run Hundred's unit: PG card fault(reserved) 0: Coast to stop 1: Fast stop 2: Stop as per stop mode 3: Continue to run Thousand's unit: off load fault 0: Coast to stop 1: Fast stop 2: Stop as per stop mode 3: Continue to run</p>		
P23.24	Fault reset	<p>Define as per bit: bit0-undervoltage;bit1- inverter overload bit2-inverter overheat ;bit3-motor overload bit4-motor overheat;bit5-user'fault 1 bit6- user'fault 2; bit7~15 reserved</p>	0	☆
P23.25	Fault source for auto reset	<p>Define as per bit: bit0-overcurrent during acceleration;bit1- overcurrent during deceleration bit2-overcurrent during constant speed;bit3-over voltage during acceleration bit4-overvoltage during deceleratoin;bit5- overvoltage during bit6-inverter undervoltage;bit7-input phase loss bit8-inverter overload;bit9-inverter overheat bit10-motor overload;bit11-motor overheat bit12-user'fault 1;bit13-user'fault 2 bit14-Reserved;bit15-Reserved</p>	0	☆
P23.26	Fault auto Reset times	0~99	0	☆
P23.27	Numeric output Action at fault reset	0:Disabled 1:Enabled	0	☆
P23.28	Interval time of fault auto reset	0.1s~300.0s	0.5s	☆
P23.29	Fault auto reset times clearing time	0.1s~3600.0s	10.0s	☆
P23.30	Continuing Running frequency selection when trip	0: Run at the set frequency 1: Run at abnormal standby frequency	0	☆
P23.31	Abnormal back-up frequency	0.00Hz~maximum frequency	2.0HZ	☆

24 Group motor Protection parameter				
P24.00	Motor overload protection gain	0.20~10.00 The larger the value, the longer the allowable overload operation, and the higher the risk of motor overheating damage.	1.00	☆
P24.01	Motor overload starting current at zero speed	50.0%~150.0%	100.0%	☆
P24.02	Motor overload starting current at Rated speed	50.0%~150.0%	115.0%	☆

Motor in self cooling mode, heat dissipation is poor when in low frequency but good in condition of high frequency . P24.01 and P24.02 is used to set the starting point of zero and rated speed overload current in order to obtain a more reasonable under different speed overload protection Time curve

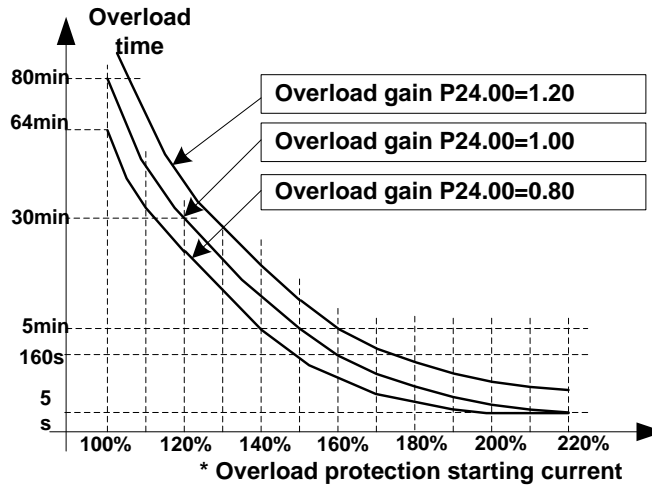
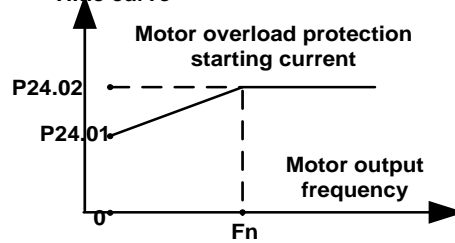

Left: Motor overload protection starting current

Right: Motor Overload Protection Curve with Different Overload Protection Gains

Motor overload only protects the motor from overload when P24.04 is enabled. P24.00 is used to adjust the overload inverse time curve time, as shown in the right figure above, the minimum motor overload time is 5.0s. Note: Users need to correctly set the three parameters of P24.00, P24.01 and P24.02 according to the actual overload capacity of the motor. If set unreasonable, prone to motor overheating damage and the inverter is not timely warning of the danger of protection.

P24.03	Motor overload warning factor	50%~100%, When the overload accumulation degree is greater than this value, the P07 group DO terminal output function code"26"(Motor overload warning) is selected and output valid signal	80%	☆
P24.04	Motor protection option	Unit'digit:Motor 1 protection selection 0:Turn off software overload protection 1:Enable software overload protection Ten's digit:Motor 2 protection selection 0:Turn off software overload protection 1:Enable software overload protection	11	☆
<p>Default inverter is —no motor temperature protection. To enable this protection, please confirm that present motor has a temperature sensor. (PTC means motor sensor,PTC1000 and PTC100 is different motor sensor type.if your motor have temperature sensor,you need to use our special card to connect PTC1000 or PTC100) and set temperature sensor type (P24.08) to start motor overheating protection.User can view present motor temperature through function code R27.07; if motor temperature is greater than motor overheating alarming threshold (P24.10), numeric output terminal —25: Motor Overload alarming is enabled and this signal is used for instruction; if motor temperature is greater than motor overheating protection threshold (P24.09), inverter will give an alarm about motor overheating fault (Er. oH3) and start corresponding protection action.</p> <p>★ Motor overheating fault (Er. oH3) can not be reset immediately until motor temperature drops to a value far below the protection threshold</p>				
P24.08	Motor temperature sensor type	0:no 1:PT100 2:PT1000 3: KTY84-130	0	☆
P24.09	Motor overheat fault threshold	0.0℃~200.0℃	120.0℃	☆
P24.10	Motor overheat warning threshold	0.0° C~200.0° C When the motor temperature detected by the temperature sensor is greater than this value, the DO terminal output function of function "27: Motor over temperature warning" is selected.	90.0℃	☆
r24.11	Motor temperature read data	Unit 0.1℃ Display the motor temperature detected by the temperature sensor	-	●
P24.12	Off load protection	0:effective 1:ineffective	0	☆
P24.13	Off load detection level	0.0%-100%	10.0%	☆
P24.14	Off load detection time	0.000s-60.000s	1.000s	☆

Off load=unload

If output current is lower than offload detection level (P24.13) and this status continues for offload detection time (P24.14) when offload detection protection is enabled (P24.12=1) and inverter is in running mode and not in DC brake, then inverter gives an offload protection fault (Er. LL) report and stops as the offload protection setting (P24.12)

25 Group Fault tracking parameter				
r25.00	Current fault type	- see detail chapter 6 fault diagnosis and solution	-	●
r25.01	Output frequency at fault	Unit:0.01Hz	-	●
r25.02	Output current at fault	Unit:0.1A	-	●
r25.03	Bus voltage at fault	Unit:V	-	●
r25.04	Running mode status 1at fault	- see Parameter r27.10 in detail	-	●
r25.05	Input terminal status at fault	Bit0~Bit6 corresponds to DI1~DI7 Bit12~Bit15 corresponds to VDI1~VDI4	-	●
r25.06	Working time at fault	Unit:0.01S	-	●
r25.07	Accumulated working time at fault	Unit:hour	-	●
r25.08	Frequency source at fault	Unit:0.01hz	-	●
r25.09	Torque source at fault	Unit:0.1% compared to motor rated torque	-	●
r25.10	Encoder speed at fault	Unit:RPM	-	●
r25.11	Electrical angle at fault	Unit: 0.1°		●
r25.12	Running mode status 2 1at fault	See Parameter r27.11 in detail	-	●
r25.13	Input terminal status at fault	Define as per unit, 0:ineffective, 1:effective Bit0: DO1; Bit1: DO2 Bit2: relay1 Bit3 (relay 2) Bit4: DO3; Bit5: DO4 Bit6: DO5; Bit7: DO6 Bit8: VDO1; Bit9: VDO2	-	●
r25.14	Heat sink temperature at fault	Unit: 0.1° C	-	●
r25.15	Low-level fault	For the fault type, see theChapter6Fault Diagnosis and Solution	-	●
r25.16	Warning type	For the fault type, see theChapter6Fault Diagnosis and Solution	-	●
26 Group Fault recording parameter				
r26.00	Last fault 1trip type	SEE DETAILS IN CHAPTER 6	-	●
r26.01	Output	Unit:0.01Hz	-	●

	frequency at fault			
r26.02	Output current at fault	Unit:0.1A	-	●
r26.03	Bus voltage at fault	Unit:V	-	●
r26.04	Running mode status 1at fault	See Parameter r27.10	-	●
r26.05	Input terminal status at fault	Bit0~Bit6 corresponds to DI1~DI7 Bit12~Bit15 corresponds to VDI1~VDI4	-	●
r26.06	working time at fault	Unit:0.01S	-	●
r26.07	Accumulated working time at fault	Unit:hour	-	●
r26.08	Last fault 2 trip type	Same as last fault description	-	●
r26.09	Output frequency at fault		-	●
r26.10	Output current at fault		-	●
r26.11	Bus voltage at fault		-	●
r26.12	Running mode status 1at fault		-	●
r26.13	Input terminal status at fault		-	●
r26.14	Working time at fault		-	●
r26.15	Accumulated working time at fault		-	●
r26.16	Last fault 3 trip type	Same as last fault description	-	●
r26.17	Output frequency at fault		-	●
r26.18	Output current at fault		-	●
r26.19	Bus voltage at fault		-	●
r26.20	Running mode status 1at fault		-	●
r26.21	Input terminal status at fault		-	●

r26.22	Working time at fault		-	●
r26.23	Accumulated working time at fault		-	●
27 Group Monitoring parameter				
r27.00	Running frequency	It can set unit as per Parameter P21.07	-	●
r27.01	Set frequency	It can set unit as per Parameter P21.07	-	●
r27.02	Direction indicator	Bit0: direction of the running frequency (0-positive direction; 1-negative direction, the same below) Bit1: Set the direction of the frequency Bit2: direction of the main frequency Bit3: direction of the secondary frequency Bit4: Direction of the UpDown offset Bit5: Direction of the encoder feedback frequency Reserved above Bit6	-	●
r27.03	Bus voltage	Unit: 1V	-	●
r27.04	Vf separation setting	unit: 0.1%	-	●
r27.05	Output voltage	unit: 0.1V	-	●
r27.06	Output current	unit: 0.1A	-	●
r27.07	Output current percentage	unit: 0.1%(100% of motor rated current)	-	●
r27.08	Output torque	0.1%	-	●
r27.09	Torque setting	0.1%	-	●
r27.10	Drives running mode status 1	Bit0:Running status 0-Stop;1-Run Bit1:Motor direction0-Forward;1-Reverse Bit2:Ready signal:0-not ready;1-ready Bit3:fault status 0-no fault;1-fault Bit4~5:fault type:0-free stop;1-fast stop;2-stop as per stop mode; 3: continue to run Bit6:jog status:0-no jog;1-jog status Bit7:Auto tune :0-no;1-yes Bit8:DC braking:0-Non DC braking;1-DC braking Bit9:Reserved Bit10~11:Acceleration and Deceleration: 0:stop/zero output;1:speed up;2:slow down;3:constant speed Bit12:Warning status: 0:no warning; 1:warning Bit13:current limit status:0-no;1-yes	-	●

		Bit14:overvoltage stalladjustment:0-no ;1-yes Bit15:undervoltage stall adjustment :0-no;1-yes		
r27.11	Drives running mode status 2	Bit0~1:current command source:0-keypad;1-terminal ;2-communicatoin Bit2~3:motor option:0-motor 1;1-motor 2 Bit4~5:current motor control:0-VF;1-SVC;2-VC Bit6~7:current running mode:0-speed;1-torque;2-position	-	●
r27.12	Drives running mode status 3	Reserved	-	●
r27.13	Drives running mode status 4	Reserved	-	●
r27.14	Accumulated power on time	Unit:hour	-	●
r27.15	Accumulated running time	Unit:hour	-	●
r27.16	Power-on time	Unit:min		
r27.18	Heat sink temperature	Unit:0.1 °C	-	●
r27.19	Main frequency	Unit:0.01Hz	-	●
r27.20	Auxiliary frequency	unit:0.01Hz	-	●
r27.21	UpDown offset frequency	unit:0.01Hz	-	●
30 Group Modbus communication parameter				
P30.00	Communication type	0:Modbus; 1:Canopen	0	★
P30.01	Drive Address	1~247 Different slaves on the same network should set different local addresses; 0 is the broadcast address, all slave inverters can be identified	1	★
P30.02	Modbus baud rate	0:1200 bps; 1:2400 bps 2:4800 bps; 3:9600 bps 4:19200 bps; 5:38400 bps 6:57600 bps; 7:115200 bps	3	★
P30.03	Modbus data format	0: 1-8-N-1 (1 start bit +8 data bits +1 stop bits) 1: 1-8-E-1 (1start bit +8 data bits +1 even parity +1 stop bit) 2: 1-8-0-1 (1 star bit+8 data bits +1odd parity+1 stop bits)	0	★

		3: 1-8-N-2 (1 star bit+8 data bits+2 stop bits) 4: 1-8-E-2 (1 star bits+8 data bit+1 even parity+2 stop bits) 5: 1-8-0-2 (1 start bit +8 data bits+1 odd parity+2 stop bits)		
P30.04	Modbus response delay	1~20msThe delay time of the local to answer the master	2ms	★
P30.05	Modbus overtime	0.0s(disabled)~60.0s(works for master-slave system) When this function code effective,if slave do not receive data from master overtime,it will trip as Er.485	0.0s	★
r30.06	Number of frames received by Modbus	Each time a frame is received, this value is incremented by 1,0 to 65535 cycles.	-	●
r30.07	Number of frames that Modbus has sent	Each time a frame is sent, this value is incremented by 1,0 to 65,536 cycles.	-	●
r30.08	Number of error frames received by Modbus	Each time an CRC error frame is received, this value is incremented by 1,0 to 65535 cycles; it can be used to judge the degree of communication interference.	-	●
P30.09	Modbus master-slave option	0: Slave 1: Master(sent by broadcast)	0	★
P30.10	Slave memory when inverter as master	1~9 corresponds to 0x7001~0x7009	1	☆
P30.11	Data sent by Master	0:output frequency 1:set frequency 2:output torque 3:set torque 4:PID setting 5:PID feedback 6:output current	0	☆
P30.12	Sending interval of Master	0.010~10.000sAs a master, after sending one frame of data, the next frame of data is sent after this delay.	0.1s	☆
P30.13	Receiving propoertaionality factor of slave	-10.000~10.000The values of slave registers 0x7001 and 0x7002 take effect after passing through this scaling factor	1.00	☆
P30.14	Communication special register	0: 0.01% 1: 0.01Hz	0	☆

	speed unit	2: 1Rpm Some units of specific communication registers can be set by this parameter. See Appendix A for details.		
P30.15	Modbus response characteristics	When the format of the received frame is a write register, this parameter can be set to reply to the host. 0: Reply to the host (standard Modbus protocol) 1: Do not reply to the host (non-standard Modbus protocol)	0	☆
31 Group Canopen communication parameter				
P31.00	CANopen communication address	1 ~ 127	1	☆
P31.01	CANopen Baud rate	0: 100k 1: 125k 2: 250k 3: 500k 4: 1M	3	☆
P31.02	CANopen overtime	1ms ~ 20ms	4ms	☆
r31.07	CANopen version number	Display the version number of the CANopen card	-	●
r31.08	CANopen Working status	0: Initialisation status 1: Disconnected 2: Connecting/Preparing- 3: Stopped 4: Operational status 5: Pre_operational	-	●
r31.10	CANopen receive error count	The number of error frames received by CANopen is not saved after power off	-	●
r31.11	CANopen send error count	The number of error frames sent by CANopen is not saved after power off	-	●
r31.12	CANopen receive frame number	The number of frames received by CANopen is not saved after power off	-	●
r31.14	CANopen send frame number	The number of frames sent by CANopen is not saved after power off	-	●
40 Group PID1 function				
r40.00	PID final output value	Read only unit:0.1%	-	●
r40.01	PID final set value	Read only	-	●

r40.02	PID final feedback value	Read only	-	●
r40.03	PID deviation value	Read only unit:0.01%	-	●

PID through the target signal (command) and the controlled amount of the difference between the feedback signal proportional (P), integral (I) and differential (D) operation, adjust the inverter output frequency, etc., to achieve closed-loop system, the controlled amount Stable at the target value.

VFD530 built-in process PID structure as shown below, suitable for flow control, pressure control, temperature control and tension control applications.

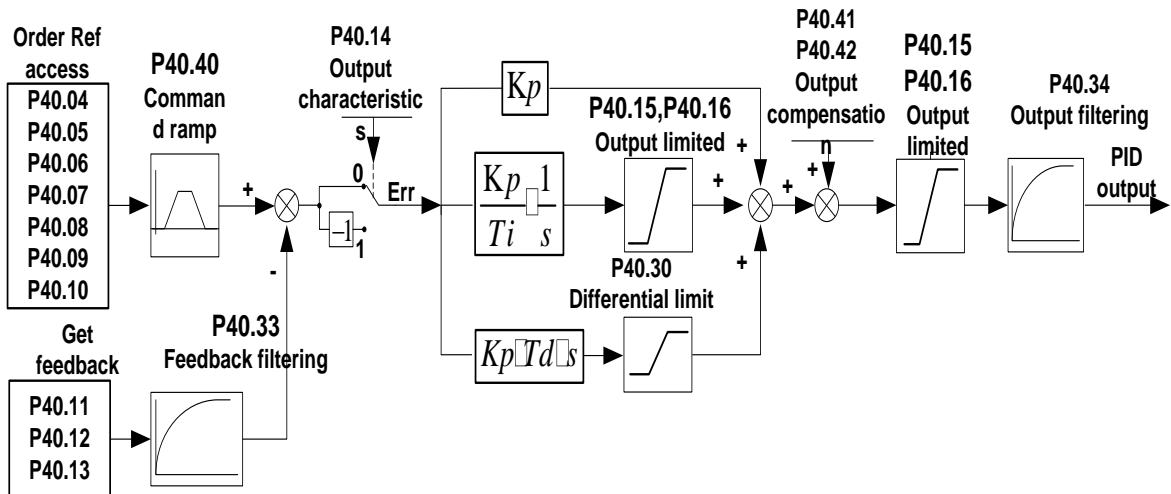

P40.04	PID reference source	Unit's digit: PID main reference source(ref1) 0: Digital setting 1: AI1 2: AI2 3: AI3(IO expansion board) 4: AI4(IO expansion board) 5: HDI high frequency pulse 6: Communication Ten's digit: PID Auxiliary reference source(ref2)Same as Unit's digit	00	☆
P40.05	PID given range	0.01~655.35	100.00	☆
P40.06	PID digital setting 0	0.0~P40.05	0.0%	☆
P40.07	PID digital setting 1	0.0~P40.05	0.0%	☆
P40.08	PID digital setting 2	0.0~P40.05	0.0%	☆
P40.09	PID digital setting 3	0.0~P40.05	0.0%	☆

When PID reference source is digital setting, PID digital setting 0~3 depends on DI terminal function 43 (preset PID terminal 1) and 44 (preset PID terminal 2):

preset PID terminal1	preset PID terminal 2	PID Digital setting value(0.1%)
ineffective	ineffective	P40.06 * 100.0% / P40.05

	ineffective	effective	P40.07 * 100.0% / P40.05	
	effective	ineffective	P40.08 * 100.0% / P40.05	
	effective	effective	P40.09 * 100.0% / P40.05	
<p>For example: When AI1 is used as PID feedback, if the full range corresponds to 16.0kg pressure and require PID control to be 8.0kg; then set P40.05 PID feedback range to 16.00, PID digital reference terminal select to P40.06, Set P40.06 (PID preset setting 0) to be 8.00</p>				
P40.10	PID reference source selection	0:ref1 1:ref1+ref2 2:ref1-ref2 3:ref1*ref2 4:ref1/ref2 5:Min(ref1,ref2) 6:Max(ref1,ref2) 7:(ref1+ref2)/2 8: fdb1and fdb2 switchover	0	☆
P40.11	PID feedback source1	Unit's digit 0: PID feedback source1(fdb1) 0:AI1 1:AI2 2:AI3(option card) 3:AI4(option card) 4: PLUSE(HDI) 5: Communication 6: Motor rated output current 7: Motor rated output frequency 8: Motor rated output torque 9: Motor rated output frequency Ten's digit : PID feedback source2 (fdb2) Same as Unit's digit	00	☆
P40.12	PID Feedback range	0.01~655.35	100.00	☆
P40.13	PID feedback function selection	0:fdb1 1:fdb1+fdb2 2:fdb1-fdb2 3:fdb1*fdb2 4:fdb1/fdb2 5:Min(fdb1,fdb2)Take fdb1.fdb2 smaller value 6:Max(fdb1,fdb2) Take fdb1.fdb2 bigger value 7: (ref1+ref2)/2 8: fdb1and fdb2 switchover	0	☆
P40.14	PID output feature	0: PID output is positive: when the feedback signal exceeds the PID reference value, the output frequency of the inverter will decrease to balance the PID. For example, the strain PID control during	0	☆

		wrapup 1: PID output is negative: When the feedback signal is stronger than the PID reference value, the output frequency of the inverter will increase to balance the PID. For example, the strain PID control during wrapdown		
<p>The PID output characteristic is determined by P40.14 and Di terminal 42 function PID positive/negative switching:</p> <p>P40.14 = 0 and "42: PID positive/negative switching" terminal is invalid: : PID output characteristic is positive P40.14 = 0 and "42: PID positive/negative switching" terminal is valid: : PID output characteristic is negative P40.14 = 1 and "42: PID positive/negative switching" terminal is invalid: : PID output characteristic is negative P40.14 = 1 and "42: PID positive/negative switching" terminal is valid: : PID output characteristic is positive</p>				
P40.15	Upper limit of PID output	-100.0%~100.0%	100.0%	☆
P40.16	lower limit of PID output	-100.0%~100.0%	0.0%	☆
P40.17	Proportional gain KP1	0.00~200.0% The function is applied to the proportional gain P of PID input. P determines the strength of the whole PID adjuster. The parameter of 100 means that when the offset of PID feedback and given value is 100%, the adjusting range of PID adjust is the Max. frequency (ignoring integral function and differential function).	5.0%	☆
P40.18	Integral time T11	0.01s~20.00s This parameter determines the speed of PID adjuster to carry out integral adjustment on the deviation of PID feedback and reference. When the deviation of PID feedback and reference is 100%, the integral adjuster works continuously after the time (ignoring the proportional effect and differential effect) to achieve the Max. Frequency (P01.06) or the Max. Voltage (P12.21). Shorter the integral time, stronger is the adjustment	1.00s	☆
P40.19	Differential time TD1	0.000s~0.100s This parameter determines the strength of the change ratio when PID adjuster carries out	0.000s	☆

		<p>integral adjustment on the deviation of PID feedback and reference.</p> <p>If the PID feedback changes 100% during the time, the adjustment of integral adjustor (ignoring the proportional effect and differential effect) is the Max. Frequency (P01.06) or the Max. Voltage (P12.21). Longer the integral time, stronger is the adjusting.</p>		
P40.20	Proportional gain KP2	0.00~200.0%.	5.0%	☆
P40.21	Integral time TI2	0.00s (no any integral effect)~20.00s	1.00s	☆
P40.22	Differential time TD2	0.000s~0.100s	0.000s	☆
P40.23	PID parameter switchover condition	<p>0: no switchover Do not switch, use KP1, TI1, TD1</p> <p>1: switchover via DI Switch by DI terminal KP1, TI1, TD1 are used when DI terminal No. 41 function is invalid; KP2, TI2, TD2 are used when valid</p> <p>2: automatic switchover based on deviation The absolute value of PID command and feedback deviation is less than P40.24, using KP1, TI1, TD1; the absolute value of deviation is greater than P40.25, using KP2, TI2, TD2 parameters; the absolute value of deviation is between P40.24~P40.25, The two sets of parameters are linearly transitioned.</p>	0	☆
P40.24	PID parameter switchover deviation 1	0.00%~P40-25	20.00%	☆
P40.25	PID parameter switchover deviation 2	P40-24~100.00%	80.00%	☆

In some applications, one group PID parameter is not enough, different PID parameters would be adopted according to the situation.

The function codes are used to switch two groups PID parameter. The setting mode of the regulator parameters P40.20~P40.22 is similar as P40.17~P40.19's.

Two groups PID parameter can be switched via DI terminal, or switched according to PID deviation automatically.

When selection is automatic switching: when the deviation absolute value between given and feedback is smaller than P40.24 (PID parameter switching deviation 1), PID parameter selection is group 1. When the

deviation absolute value between given and feedback is bigger than P40.25 (PID parameter switching deviation 2), PID parameter selection is group 2. When the deviation absolute value between given and feedback is between P40.24 and P40.25, PID parameter is the linear interpolation of two groups PID parameter, showed as below

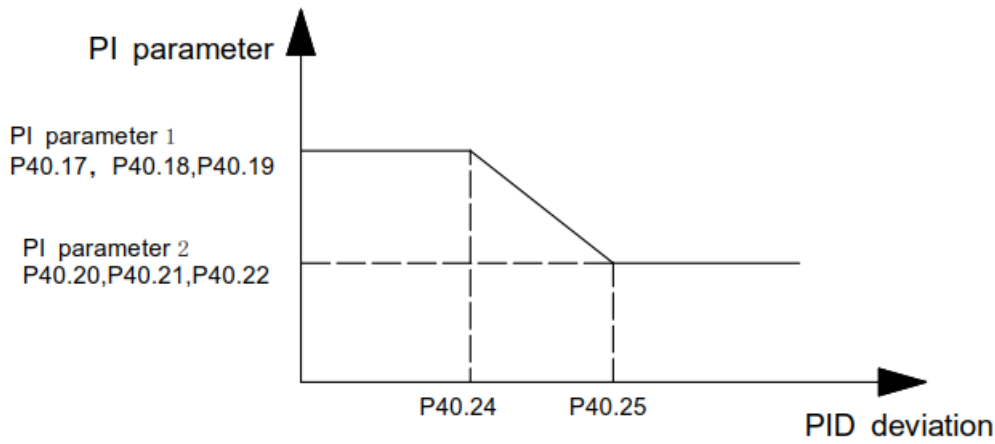

parameter switching diagram

P40.26	PID integral separation threshold	0.0%~100.00%	100.00%	☆
P40.27	PID initial value	0.0%~100.0%	0.0%	☆
P40.28	PID initial value holding time	0.00~650.00s	0.00s	☆

This function is only valid when P40.39 = 0 which is not calculated. The PID output is reset after the inverter stops. If P40.28 ≠ 0, when the inverter runs, the PID output is equal to the initial value of PID and keeps the time of P40.28.

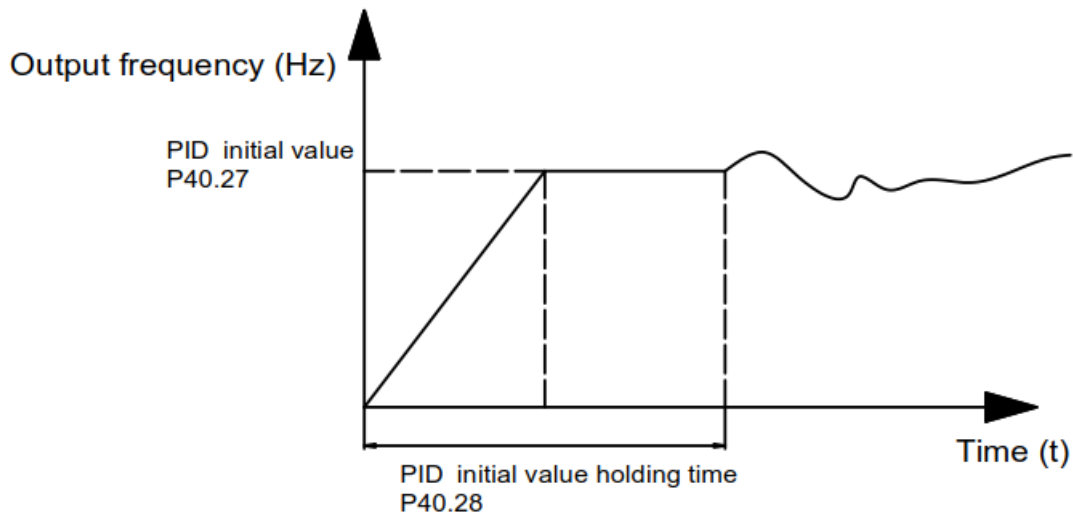

PID initial value function diagram

P40.29	PID deviation limit	0.0%~100.0% The output of PID system is relative to the maximum deviation of the close loop reference. As	0.0%	☆
--------	---------------------	--	------	---

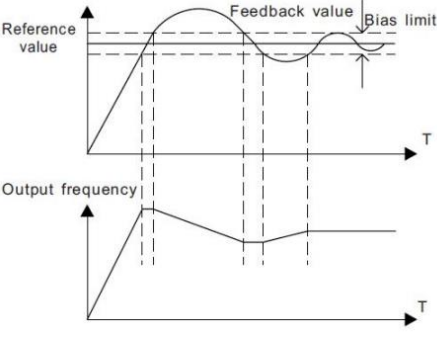
		<p>shown in the diagram below, PID adjustor stops to work during the deviation limit. Set the function properly to adjust the accuracy and stability of the system.</p> 		
P40.30	PID differential limit	0.00%~100.00%	1.00%	☆
P40.33	PID feedback filter time	0.000~30.000s	0.010s	☆
P40.34	PID output filter time	0.000~30.000s	0.010s	☆
P40.35	Detection value of PID feedback loss (lower limit)	0.00%(no detection)~100.00%	0.00%	☆
P40.36	Detection time of PID feedback loss	0.000s~30.000s	0.000s	☆
P40.37	Detection value of PID feedback loss(upper limit)	0.0%~100.00%(no detection)	100.00%	☆
P40.38	Upper Detection time of PID feedback loss	0.000s~30.000s	0.000s	☆
P40.39	PID operation at stop	0-No PID operation at stop 1-PID operation at stop	0	☆
P40.40	PID command for accel and decel time	0.0s~6000.0s	0.0s	☆
P40.41	PID offset selection	0-digital setting 1-AI1 2-AI2 3-AI3(option card)	0	☆
P40.42	PID offset digital setting	-100.0%~100.0%	0.0%	☆

41 Group Sleeping function				
P41.00	Sleep mode and wake up selection	<p>Unit's digit: sleep mode selection</p> <p>0:no sleep function 1:sleep by frequency 2:AI1 sleep (AI1 as pressure feedback) 3:AI2 sleep(AI2 as pressure feedback) 4:AI3 sleep (AI3 as pressure feedback) 3:AI4 sleep(AI4 as pressure feedback)</p> <p>Ten's digit : wake up mode selection</p> <p>0:wake up by frequency 1:AI1 wake up (AI1 as pressure feedback) 2:AI2 wake up (AI2 as pressure feedback) 3:AI3 wake up (AI3 as pressure feedback) 4:AI4 wake up (AI4 as pressure feedback)</p> <p>Hundred's digit: Sleep wake direction selection</p> <p>0: positive direction Sleep source (AI1 ~ AI4) > P41.03, inverter will sleep Wake-up source (AI1 ~ AI4) < P41.04, the inverter will wake up</p> <p>1: reverse direction Sleep source (AI1 ~ AI4) < P41.03, inverter sleep Wake-up source (AI1 ~ AI4) > P41.04, the inverter wakes up.</p> <p>➤ When the sleep source and wakeup source are the same, please pay attention to the size relationship of P41.03 and P41.04. If the parameter setting is unreasonable, when the wake-up condition is selected, even if the sleep condition is established, the sleep state cannot be entered, and special attention is required when using.</p>	010	☆
P41.01	Sleep setting value by frequency	0.00Hz~600HZ,It will sleep if value is less than this value	0.00Hz	☆
P41.02	Wake up threshold by	0.00hz~600.00hz, ,It will wake up if value is bigger than this value	0.00Hz	☆

	frequency			
When selecting frequency sleep and frequency wake-up, it must be set by P41.01 < P41.02. When the frequency source is PID setting, and the frequency wake-up must be set to PID shutdown operation: P40.39 = 1.				
P41.03	Sleep setting value by pressure	0~100.0%	0.0%	☆
P41.04	Wake up threshold by pressure	0.~100.0%	0.0%	☆
P41.05	Sleep delay time	0.0s~6000.0s	0.0s	☆
P41.06	Wake up delay up	0.0s~6000.0s	0.0s	☆
P41.07	Sleep decelerating time	Setting value decide by P03.16 P03.16 = 2, 0.00~600.00s; P03.16 = 1, 0.0s~6000.0s; P03.16 = 0, 0s~60000s P41.07 set to 0, sleeping stop mode to free coast.	0.00s	☆
42 Group Simple PLC				
r42.00	PLC current running mode	Read only	-	●
r42.01	PLC current running remaining time	Read only	-	●
r42.02	PLC times of cycles	Read only	-	●
P42.03	Simple PLC running mode	Unit'digit: 0: single cycle then stop 1: single cycle then keep last speed 2: recycle 3: Plc reset when single cycle stop Ten's digit: 0:power off without saving 1:power off with saving Hundred'digit: 0:stop without saving 1:stop with saving 0 : Restart from the first stage; stop during running (cause by the stop command, fault or power loss), run from the first stage after restart. 1 : Continue to run from the stop frequency; stop during running(cause by stop command and fault), the inverter will record the running time automatically, enter into the	003	☆

		stage after restart and keep the remaining running at the setting frequency.		
P42.04	PLC running times	1~60000	1	☆
P42.05	PLC step 1 running time	0.0~6553.5 unit depend on P42.21 Notice:Running time do not conclude acceleration and deceleration time,same as following	0.0	☆
P42.06	PLC step 2 running time	0.0~6553.5 unit depend on P42.21	0.0	☆
P42.07	PLC step 3 running time	0.0~6553.5 unit depend on P42.21	0.0	☆
P42.08	PLC step 4 running time	0.0~6553.5 unit depend on P42.21	0.0	☆
P42.09	PLC step 5 running time	0.0~6553.5 unit depend on P42.21	0.0	☆
P42.10	PLC step 6 running time	0.0~6553.5 unit depend on P42.21	0.0	☆
P42.11	PLC step 7 running time	0.0~6553.5 unit depend on P42.21	0.0	☆
P42.12	PLC step 8 running time	0.0~6553.5 unit depend on P42.21	0.0	☆
P42.13	PLC step 9 running time	0.0~6553.5 unit depend on P42.21	0.0	☆
P42.14	PLC step 10 running time	0.0~6553.5 unit depend on P42.21	0.0	☆
P42.15	PLC step 11 running time	0.0~6553.5 unit depend on P42.21	0.0	☆
P42.16	PLC step 12 running time	0.0~6553.5 unit depend on P42.21	0.0	☆
P42.17	PLC step 13 running time	0.0~6553.5 unit depend on P42.21	0.0	☆
P42.18	PLC step 14 running time	0.0~6553.5 unit depend on P42.21	0.0	☆
P42.19	PLC step 15 running time	0.0~6553.5 unit depend on P42.21	0.0	☆
P42.20	PLC step 16 running time	0.0~6553.5 unit depend on P42.21	0.0	☆
P42.21	PLC running time unit	0:S; 1:minute; 2:hour	0	☆

P42.22	PLC step 1-4 ACCEL/DECEL time selector	Unit'digit: step 1 ACCEL/DECEL time selector ten'digit: step 2 ACCEL/DECEL time selector Hundred's: step 3 ACCEL/DECEL time selector Thousand'unit: step 4 ACCEL/DECEL time selector 0- ACCEL/DECEL time 1 1- ACCEL/DECEL time 2 2- ACCEL/DECEL time 3 3- ACCEL/DECEL time 4	0000	☆
P42.23	PLC step 5-8 ACCEL/DECEL time selector	Unit'digit: ACCEL/DECEL time 5 Ten'digit: ACCEL/DECEL time 6 Hundred'digit: ACCEL/DECEL time 7 Thousand'digit: ACCEL/DECEL time 8 0- ACCEL/DECEL time 1 1- ACCEL/DECEL time 2 2- ACCEL/DECEL time 3 3- ACCEL/DECEL time 4	0000	☆
P42.24	PLC step 9-12 ACCEL/DECEL time selector	Unit'digit: ACCEL/DECEL time 9 ten'digit: ACCEL/DECEL time 10 Hundred'digit: ACCEL/DECEL time 11 Thousand'digit: ACCEL/DECEL time 12 0- ACCEL/DECEL time 1 1- ACCEL/DECEL time 2 2- ACCEL/DECEL time 3 3- ACCEL/DECEL time 4	0000	☆
P42.25	PLC step 13-16 ACCEL/DECEL time selector	Unit's Digit: ACCEL/DECEL time 13 Ten'Digit: ACCEL/DECEL time 14 Hundred'digit: ACCEL/DECEL time 15 Thousand's digit: ACCEL/DECEL tim 16 0- ACCEL/DECEL time 1 1- ACCEL/DECEL time 2 2- ACCEL/DECEL time 3 3- ACCEL/DECEL time 4	0000	☆
P42.26	PLC stop decelerating time	0.01~60000s Setting value decide by P03.16 P03.16 = 2, 0.00~600.00s; P03.16 = 1, 0.0s~6000.0s; P03.16 = 0, 0s~60000s	20.00s	☆
43 Group Programming delay-unit				
r43.00	Delay unit output status	It is used to view the current output status of the delay unit. Bit definition is used, Bit0~Bit3 respectively indicate the output status of delay units 1~4,	-	●

		0 means invalid, 1 means valid.		
--	--	---------------------------------	--	--

VFD530 inverter built-in 4 delay unit. The delay unit can collect the status of 0 ~ 15 bits of all parameters that can be viewed in the function code table, and finally output the delay unit status after delay processing and logic selection. Can be used for DI / DO, comparator / logic unit output delay and other functions, but also as a virtual relay.

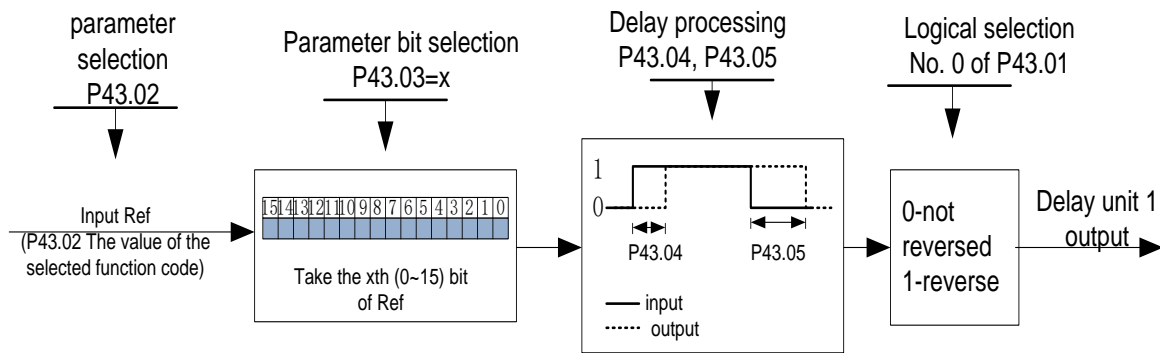

Delay unit 1 block diagram

The picture shows the delay unit 1 block diagram, delay unit 2 to 4 and so on. Delay unitsDelay can be used for DI/DO delay processing also can be combined with comparator units and logic units for more complex applications.

P43.01	Delay unit 1-4 logic	0000B~1111B Bit0~Bit3 corresponds to delay units 1~4, which are used to specify whether the output of the delay unit is inverted.	0	☆
P43.02	Delay unit 1 input parameter selection	00.00-98.99(function code index)	00.00	☆
P43.03	Delay unit 1 input bit selection	0-15	0	☆
P43.04	Delay unit 1 rising edge delay time	0.0s~3000.0s	0.0s	☆
P43.05	Delay unit 1 descending edge delay time	0.0s~3000.0s	0.0s	☆
P43.06	Delay unit 2 input parameter selection	00.00-98.99(function code index)	00.00	☆
P43.07	Delay unit 2 input bit selection	0-15	0	☆
P43.08	Delay unit2 rising edge delay time	0.0s~3000.0s	0.0s	☆
P43.09	Delay	0.0s~3000.0s	0.0s	☆

	unit2descending edge delay time			
P43.10	Delay unit 3 input parameter selection	00.00-98.99(function code index)	00.00	☆
P43.11	Delay unit 3 input bit selection	0-15	0	☆
P43.12	Delay unit3 rising edge delay time	0.0s~3000.0s	0.0s	☆
P43.13	Delay unit3descending edge delay time	0.0s~3000.0s	0.0s	☆
P43.14	Delay unit 4 input parameter selection	00.00-98.99(function code index)	00.00	☆
P43.15	Delay unit 4 input bit selection	0-15	0	☆
P43.16	Delay unit4 rising edge delay time	0.0s~3000.0s	0.0s	☆
P43.17	Delay unit4descending edge delay time	0.0s~3000.0s	0.0s	☆
44 Group Variable selector and logic block				
r44.00	Variable selector 1~4 output	bit0~3 indicate the output of variable selector 1-4	-	●
r44.01	Logic block 1~4 output	bit0~3 indicate the output of logic block 1~ 4	-	●
P44.02	Variable selector 1 input parameter	00.00~98.99(Function code index)	00.00	☆
P44.03	Variableselector 1 threshold	00.00~98.99(Function code index)	00.00	☆
P44.04	Variable selector 1 logic mode	0:>; 1:<; 2:≥;3:≤;4:=; 5:≠; 6:≈	0	☆
P44.05	Variableselector 1 hysteresis width	0~65535	0	☆
<p>VFD530 inbuilt 4 group variable selector,this function can be used for any two function code parameters,by selecting the comparison relationship, and output will be 1 if it meet conditions or it will be 0.Variable selector output can act as DI,VDI,virtual relay input and DO,relay.etc output.Users can easily and flexibly get logic function ,variable selector 1 frame as follows</p>				

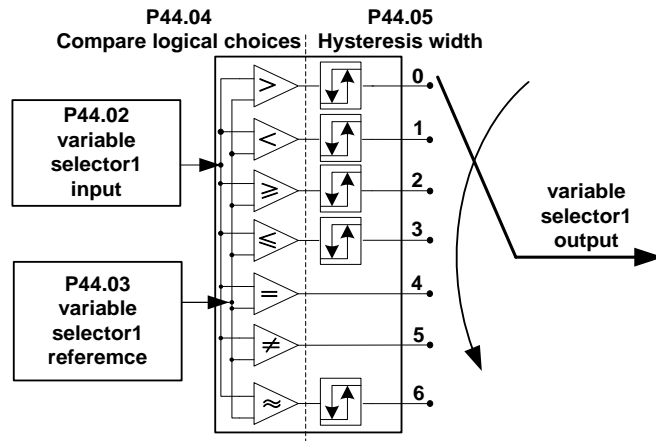

Left:variable selector graph Right: hysteresis width graph

P44.06	Variable selector 2 input parameter	00.00-98.99(function code index)	00.00	☆
P44.07	Variable selector 2 threshold	00.00-98.99(function code index)	00.00	☆
P44.08	Variable selector 2 logic mode	0:>; 1:<; 2:≥;3:≤;4:=; 5:≠; 6:≈	0	☆
P44.09	Variable selector 2 hysteresis width	0~65535	0	☆
P44.10	Variable selector 3 input parameter	00.00-98.99(function code index)	00.00	☆
P44.11	Variable selector 3 threshold	00.00-98.99(function code index)	00.00	☆
P44.12	Variable selector 3 logic mode	0:>; 1:<; 2:≥;3:≤;4:=; 5:≠; 6:≈	0	☆
P44.13	Variable selector 3 hysteresis width	0~65535	0	☆
P44.14	Variable selector 4 input parameter	00.00-98.99(function code index)	00.00	☆
P44.15	Variable selector 4 threshold	00.00-98.99(function code index)	00.00	☆
P44.16	Variable selector 4 logic mode	0:>; 1:<; 2:≥;3:≤;4:=; 5:≠; 6:≈	0	☆
P44.17	Variable selector 4 hysteresis width	0~65535	0	☆
P44.18	Logic block 1 threshold parameter 1	00.00-98.99(function code index)	00.00	☆

P44.19	Logic block 1 threshold parameter2	00.00-98.99(function code index)	00.00	☆
P44.20	Logic block 1 input source	Unit'digit: parameter 1 bit selection 0-F (Represent 0-15),P44.18 corresponds to 0-15 bit Ten'digit:parameter 2 bit selection 0-F (Represent 0-15),P44.19 corresponds to 0-15 bit	0	
P44.21	Logic bock 1 function	0:no function;1:and; 2:or; 3:not and; 4:not or; 5: exclusive OR 6:Ref=1 effective;Ref2=1 ineffective 7:Ref1 up effective,Ref2 up ineffective 8:Ref1 up and signal reverse 9:Ref1 up and output 200ms pulse width	0	☆
<p>VFD530 built-in 4 logical units. The logic unit can perform any one of 0-15 bits of any parameter 1 and any one of 0-15 bits of any parameter 2 for logic processing. The condition is true output 1, otherwise 0 is output. Logic unit output can be used as DI, VDI, delay unit and other inputs, DO, relays and other output, the user can more flexible access to the required logic. The schematic block diagram of the logic unit 1 is as follows.</p>				
P44.22	Logic block 2 threshold parameter 1	00.00-98.99(function code index)	00.00	☆
P44.23	Logic block 2 threshold parameter2	00.00-98.99(function code index)	00.00	☆
P44.24	Logic block 2 input source	Unit'digit: parameter 1 bit selection 0-F (Represent 0-15),P44.22 corresponds to 0-15 bit Ten'digit:parameter 2 bit selection 0-F (Represent 0-15),P44.23 corresponds to 0-15 bit	0	☆
P44.25	Logic bock 2 function	0:no function; 1:and; 2:or; 3:not and;	0	☆

		4:not or; 5: exclusive OR 6:Ref=1 effective;Ref2=1 ineffective 7:Ref1 up effective,Ref2 up ineffective 8:Ref1 up and signal reverse 9:Ref1 up and output 200ms pulse width		
P44.26	Logic block 3 threshold parameter 1	00.00-98.99(function code index)	00.00	☆
P44.27	Logic block 3 threshold parameter2	00.00-98.99(function code index)	0	☆
P44.28	Logic block 3 input source	Unit'digit: parameter 1 bit selection 0-F (Represent 0-15),P44.26 corresponds to 0-15 bit Ten'digit:parameter 2 bit selection 0-F (Represent 0-15),P44.27 corresponds to 0-15 bit	0	☆
P44.29	Logic bock 3 function	0:no function; 1:and; 2:or; 3:not and; 4:not or; 5: exclusive OR 6:Ref=1 effective;Ref2=1 ineffective 7:Ref1 up effective,Ref2 up ineffective 8:Ref1 up and signal reverse 9:Ref1 up and output 200ms pulse width	0	☆
P44.30	Logic block 4 threshold parameter 1	00.00-98.99(function code index)	00.00	☆
P44.31	Logic block 4 threshold parameter2	00.00-98.99(function code index)	00.00	☆
P44.32	Logic block 4 input source	Unit'digit: parameter 1 bit selection 0-F (Represent 0-15),P44.30 corresponds to 0-15 bit Ten'digit:parameter 2 bit selection 0-F (Represent 0-15),P44.31 corresponds to 0-15 bit	0	☆
P44.33	Logic bock 4 function	0:no function; 1:and; 2:or; 3:not and; 4:not or; 5: exclusive OR 6:Ref=1 effective;Ref2=1 ineffective	0	☆

		7:Ref1 up effective,Ref2 up ineffective 8:Ref1 up and signal reverse 9:Ref1 up and output 200ms pulse width		
P44.34	Constant setting 1	0~65535	0	☆
P44.35	Constant setting 2	0~65535	0	☆
P44.36	Constant setting 3	0~65535	0	☆
P44.37	Constant setting 4	-9999~9999	0	☆
P44.38	Constant setting 1 as per bit definition	0~65535(define as bit)	0	☆
P44.39	Constant setting 2 as per bit definition	0~65535(define as bit)	0	☆
P44.40	Constant setting 3 as per bit definition	0~65535(define as bit)	0	☆
P44.41	Constant setting 4 as per bit definition	0~65535(define as bit)	0	☆
Constant setting for reference of variable selector or logic block input				
45 Group Multi-functional counter				
r45.00	Counter 1 input value	The count value before the electronic gear, that is, the number of pulses received by the counter 1 hardware, 32-bit read-only data	-	●
r45.02	Counter 1 count value	Count value after electronic gear, 32-bit read-only data	-	●
P45.04	Counter 1 set value	1 to 4294967295, when the counter 1 count value (after the electronic gear) reaches this setting, the DO function "Counter 1 set value reached" is valid.	1000	☆
P45.06	Counter 1 maximum value	1 to 4294967295, set the maximum value of counter 1 (after electronic gear)	429496729 5	☆
P45.08	Counter 1 Electronic gear numerator	1~65535 Counter 1 count value = counter 1 input value ×(electronic gear numerator / electronic gear denominator)	1	☆
P45.09	Counter 1 Electronic gear denominator	1~65535	1	☆

VFD530 has two inbuilt counters: Counter 1 is a 32-bit multifunction counter with electronic gears; counter 2 is a 16-bit normal counter with no electronic gear function. Now take the counter 1 as an example to briefly explain its function and use, and the counter 2 will not be specified.

The counter 1 receives the pulse signal through the terminal corresponding to the DI function "Counter 1 input", and the pulse signal is used for the counter 1 counting after passing through the electronic gear. When the count value reaches the set value (P45.04), the DO function "Counter 1 set value reached" is valid; when the count value reaches the maximum value (P45.06), select whether to stop counting or reset the count according to P45.13. value.

The counter can also be reset by the DI terminal. When the DI Terminal is the "Counter 1 reset" function and the terminal is valid, the counter 1 is reset.

For example: P45.04=3, P45.08=3, P45.09=1, the function of counter 1 is as shown below.

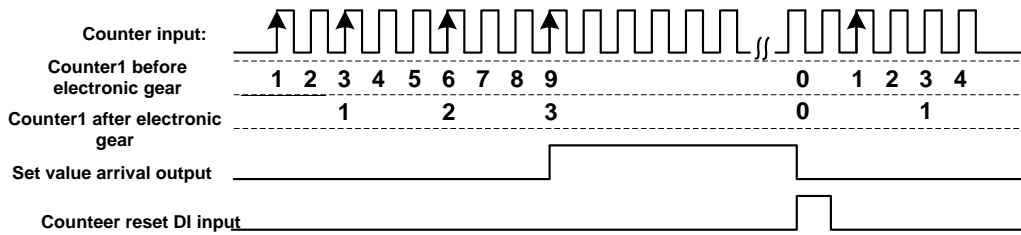

By setting a reasonable electronic gear, the counter 1 can realize functions such as fixed length in addition to the counting function, and the user can flexibly use it in specific applications.

r45.10	Counter 2 actual value	Read only	-	●
P45.11	Counter 2 set value	When the counter 2 count value (after the electronic gear) reaches this setting, the DO function "Counter 2 set value reached" is valid.setting range: 1~65535	1000	☆
P45.12	Counter 2 maximum value	1 to 65535, set the maximum value of counter 2. Setting range: 1~65535	65535	☆
P45.13	Counter 1 control	Unit'digit: counting method 0: Stop counting after counting the maximum value 1: Reset after counting the maximum value, recount from 0 Ten'sdigit: the action after the counter reaches the set value 0: continue to run 1: Free stop 2: Ramp to stop 3: Emergency stop Hundred's digit : Power-down save option 0: Do not save the count value when power is off 1: save the count value when power is off	001	☆
P45.14	Counter 2 control	Unit'digit: counting method 0: Stop counting after counting the maximum value 1: Reset after counting the maximum value,	100	☆

		recount from 0 Ten's digit: the action after the counter reaches the set value 0: continue to run 1: Free stop 2: Ramp to stop 3: Emergency stop Hundred's digit : Power-down save option 0: Do not save the count value when power is off 1: save the count value when power is off		
--	--	--	--	--

Count 1/2 overflow action:when counter higher than maximum value as following chart

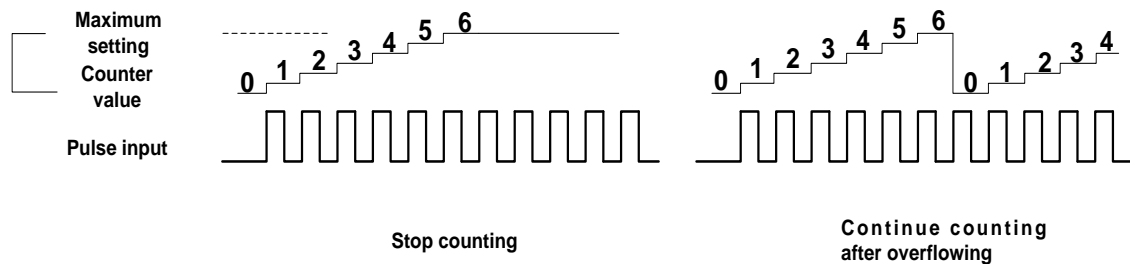

50 Group PID 2 function

r50.00	PID final output value	Read only unit:0.1%	-	●
r50.01	PID final set value	Read only unit:0.1%	-	●
r50.02	PID final feedback value	Read only unit:0.1%	-	●
r50.03	PID deviation value	Read only unit:0.1%	-	●

PID through the target signal (command) and the controlled amount of the difference between the feedback signal proportional (P), integral (I) and differential (D) operation, adjust the inverter output frequency, etc., to achieve closed-loop system, the controlled amount Stable at the target value.

VFD530 built-in process PID structure as shown below, suitable for flow control, pressure control, temperature control and tension control applications.

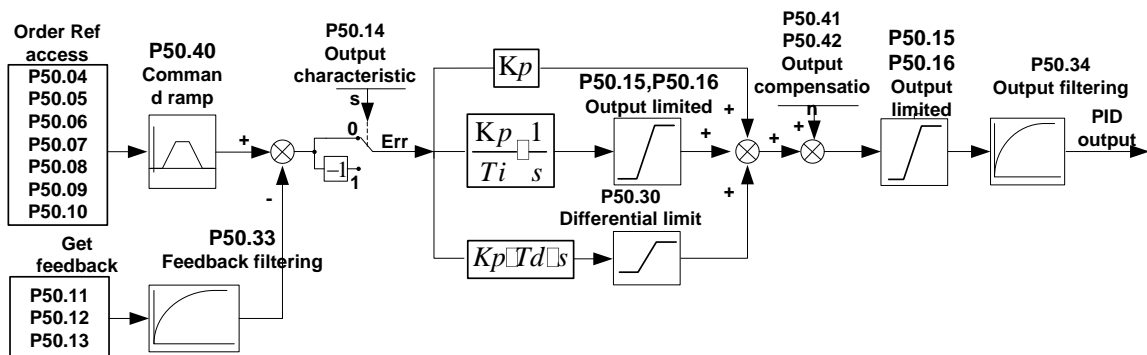

P50.04	PID reference source	Unit's digit:PID main reference source(ref1) 0: Digital setting 1: AI1	00	☆
---------------	-----------------------------	--	----	---

		2: AI2 3: AI3(IO expansion board) 4: AI4(IO expansion board) 5: HDI high frequency pulse 6: Communication Ten's digit: PID Auxiliary reference source(ref2)Same as Unit's digit		
P50.05	PID given feedback range	0.01~655.35	100.00	☆
P50.06	PID digital setting 0	0.0~P40.05	0.0%	☆
P50.07	PID digital setting 1	0.0~P40.05	0.0%	☆
P50.08	PID digital setting 2	0.0~P40.05	0.0%	☆
P50.09	PID digital setting 3	0.0~P40.05	0.0%	☆

When PID reference source is digital setting, PID digital setting 0~3 depends on DI terminal function 68 (preset PID terminal 1) and 69 (preset PID terminal 2):

preset PID terminal1	preset PID terminal 2	PID Digital setting value(0.1%)
ineffective	ineffective	$P50.06 * 100.0\% / P50.05$
ineffective	effective	$P50.07 * 100.0\% / P50.05$
effective	ineffective	$P50.08 * 100.0\% / P50.05$
effective	effective	$P50.09 * 100.0\% / P50.05$

For example: When AI1 is used as PID feedback, if the full range corresponds to 16.0kg pressure and require PID control to be 8.0kg; then set P50.05 PID feedback range to 16.00, PID digital reference terminal select to P50.06, Set P50.06 (PID preset setting 0) to be 8.00

P50.10	PID reference source selection	0:ref1 1:ref1+ref2 2:ref1-ref2 3:ref1*ref2 4:ref1/ref2 5:Min(ref1,ref2) 6:Max(ref1,ref2) 7:(ref1+ref2)/2 8: fdb1 and fdb2 switchover	0	☆
P50.11	PID feedback source1	Unit's digit 0: PID feedback source1(fdb1) 0:AI1 1:AI2 2:AI3(option card) 3:AI4(option card) 4: PLUSE(HDI) 5: Communication 6: Motor rated output current 7: Motor rated output frequency	00	☆

		8: Motor rated output torque 9: Motor rated output frequency Ten's digit : PID feedback source2 (fdb2) Same as Unit's digit		
P50.13	PID feedback function selection	0:fdb1 1:fdb1+fdb2 2:fdb1-fdb2 3:fdb1*fdb2 4:fdb1/fdb2 5:Min(fdb1,fdb2)Take fdb1.fdb2 smaller value 6:Max(fdb1,fdb2) Take fdb1.fdb2 bigger value 7: (ref1+ref2)/2 8: fdb1and fdb2 switchover	0	☆
P50.14	PID output feature	0: PID output is positive: when the feedback signal exceeds the PID reference value, the output frequency of the inverter will decrease to balance the PID. For example, the strain PID control during wrapup 1: PID output is negative: When the feedback signal is stronger than the PID reference value, the output frequency of the inverter will increase to balance the PID. For example, the strain PID control during wrapdown	0	☆
<p>The PID output characteristic is determined by P50.14 and Di terminal 67 function PID positive/negative switching:</p> <p>P50.14 = 0 and "67: PID positive/negative switching" terminal is invalid: : PID output characteristic is positive P50.14 = 0 and "67: PID positive/negative switching" terminal is valid: : PID output characteristic is negative P50.14 = 1 and "67: PID positive/negative switching" terminal is invalid: : PID output characteristic is negative P50.14 = 1 and "67: PID positive/negative switching" terminal is valid: : PID output characteristic is positive</p>				
P50.15	Upper limit of PID output	-100.0%~100.0%	100.0%	☆
P50.16	lower limit of PID output	-100.0%~100.0%	0.0%	☆
P50.17	Proportional gain KP1	0.00~200.0% The function is applied to the proportional gain P of PID input. P determines the strength of the whole PID adjuster. The parameter of 100 means that when the offset of PID feedback and given value is 100%, the adjusting range of PID	5.0%	☆

		adjust is the Max. frequency (ignoring integral function and differential function).		
P50.18	Integral time T11	0.01s~20.00s This parameter determines the speed of PID adjustor to carry out integral adjustment on the deviation of PID feedback and reference. When the deviation of PID feedback and reference is 100%, the integral adjustor works continuously after the time (ignoring the proportional effect and differential effect) to achieve the Max. Frequency (P01.06) or the Max. Voltage (P12.21). Shorter the integral time, stronger is the adjustment	1.00s	☆
P50.19	Differential time TD1	0.000s~0.100s This parameter determines the strength of the change ratio when PID adjustor carries out integral adjustment on the deviation of PID feedback and reference. If the PID feedback changes 100% during the time, the adjustment of integral adjustor (ignoring the proportional effect and differential effect) is the Max. Frequency (P01.06) or the Max. Voltage (P12.21). Longer the integral time, stronger is the adjusting.	0.000s	☆
P50.20	Proportional gain KP2	0.00~200.0%.	5.0%	☆
P50.21	Integral time T12	0.00s (no any integral effect)~20.00s	1.00s	☆
P50.22	Differential time TD2	0.000s~0.100s	0.000s	☆
P50.23	PID parameter switchover condition	0: no switchover Do not switch, use KP1, T11, TD1 1: switchover via DI Switch by DI terminal KP1, T11, TD1 are used when DI terminal No. 66 function is invalid; KP2, T12, TD2 are used when valid 2: automatic switchover based on deviation The absolute value of PID command and feedback deviation is less than P50.24, using	0	☆

		KP1, TI1, TD1; the absolute value of deviation is greater than P50.25, using KP2, TI2, TD2 parameters; the absolute value of deviation is between P50.24~P50.25, The two sets of parameters are linearly transitioned.		
P50.24	PID parameter switchover deviation 1	0.0%~P50-25	20.0%	☆
P50.25	PID parameter switchover deviation 2	P50-24~100.0%	80.0%	☆
P50.26	PID integral separation threshold	0.0%~100.0%	100.0%	☆
P50.27	PID initial value	0.0%~100.0%	0.0%	☆
P50.28	PID initial value holding time	0.00~650.00s	0.00s	☆
This function is only valid when P50.39 = 0 which is not calculated. The PID output is reset after the inverter stops. If P50.28 \neq 0, when the inverter runs, the PID output is equal to the initial value of PID and keeps the time of P50.28.				
P50.29	PID deviation limit	0.0%~100.0% The output of PID system is relative to the maximum deviation of the close loop reference. As shown in the diagram below, PID adjustor stops to work during the deviation limit. Set the function properly to adjust the accuracy and stability of the system.	0.0%	☆
P50.30	PID differential limit	0.00%~100.00%	1.00%	☆
P50.33	PID feedback filter time	0.000~30.000s	0.010s	☆

P50.34	PID output filter time	0.000~30.000s	0.010s	☆
P50.35	Detection value of PID feedback loss (lower limit)	0.0%(no detection)~100.0%	0.0%	☆
P50.36	Detection time of PID feedback loss	0.000s~30.000s	0.000s	☆
P50.37	Detection value of PID feedback loss(upper limit)	0.0%~100.0%(no detection)	100.0%	☆
P50.38	Upper Detection time of PID feedback loss	0.000s~30.000s	0.000s	☆
P50.39	PID operation at stop	0-No PID operation at stop 1-PID operation at stop	0	☆
P50.40	PID command for accel and decel time	0.0s~6000.0s	0.0s	☆
P50.41	PID offset selection	0-digital setting 1-AI1 2-AI2 3-AI3(option card)	0	☆
P50.42	PID offset digital setting	-100.0%~100.0%	0.0%	☆
60 Group Motor 2 basic parameter				
P60.00	Control mode	Same as P00.04	0	★
P60.01	Upper limit frequency	Same as P01.07	0	★
P60.02	Upper limit frequency digital setting	Lower limit (P01.09) ~ maximum frequency(P01.06)	50.00Hz	☆
P60.04	Accel and Decel time option	0: same as motor 1 1: Accel and Decel time 3 When choose 1, Motor 2 can convert between accel and decel time 3 and 4 by DI terminal function code 55 or switch by output frequency comparing with P60.05 P60.06)	0	★
P60.05	Accel time frequency switchover 2	0.00Hz~maximum frequency (P01.06)	0.00Hz	☆
P60.06	Decel time frequency switchover 2	0.00Hz~maximum frequency(P01.06)	0.00Hz	☆

61 Group Motor2 parameter
61.xx same as motor 1 parameter P11.xx
62 Group Motor 2 VF control parameter
62.xx same as motor 1 VF control P12.xx
63 Group Motor 2 Vector control parameter
63.xx same as motor 2 Vector control P13.xx

Chapter 6 Fault Diagnosis and Solution

6.1 Failure and diagnosis

The VFD530 inverter has perfect protection. If a fault occurs, the inverter will act according to the fault attribute. For more serious faults, the inverter will directly block the output; for general faults, it can be configured to stop or continue to operate according to the scheduled stop mode. After the inverter fails, the fault relay contacts act and the fault code is displayed on the display panel. Before seeking service, users can perform self-checking according to the tips in this section, analyze the cause of the fault, and find a solution.

Fault Name	Fault code	Display	Possible Causes	Solutions
Inverter unit protection	1	Er. SC Er. SC	1: Motor insulation aging 2: The cable is damaged and contact, short circuit 3: The distance between motor and inverter are too long. 4: Output transistor breakdown 5: The internal wiring of the inverter is loose, or the hardware is bad. 6: Brake transistor short circuit	1. Confirm the insulation resistance of the motor. If it is turned on, replace the motor. 2. Check the power cable of the motor 3. Install reactor or output filter 4, seeking technical support 5, seeking technical support 6. Check if the braking resistor is damaged and the wiring is correct.
Over current during acceleration	2	Er.OC1 Er.OC1	1: The output circuit is grounded or short circuited. 2: Motor auto-tuning is not performed. 3: The acceleration time is too short. 4: Manual torque boost or V/F curve is not appropriate. 5: The voltage is too low. 6: The startup operation is performed on the rotating motor. 7: A sudden load is added during acceleration. 8: The frequency inverter model is of too small power class.	1: Eliminate external faults. 2: Perform the motor auto-tuning in cold state 3: Increase the acceleration time. 4: Adjust the manual torque boost or V/F curve. 5: Adjust the voltage to normal range. 6: Select rotational speed tracking restart or start the motor after it stops. 7: Remove the added load. 8: Select a frequency inverter Of higher power class.
Over current during deceleration	3	Er.OC2 Er.OC2	1: The output circuit is grounded or short circuited. 2: Motor auto-tuning is not performed. 3: The deceleration time is too short. 4: The voltage is too low. 5: A sudden load is added during deceleration. 6: The braking unit and braking resistor are not installed	1: Eliminate external faults. 2: Perform the motor auto-tuning. 3: Increase the deceleration time. 4: Adjust the voltage to normal range. 5: Remove the added load. 6: Install the braking unit And braking resistor.

Fault Name	Fault code	Display	Possible Causes	Solutions
Over current at constant speed	4	Er.OC3 Er.oC3	1: The output circuit is grounded or short circuited. 2: Motor auto-tuning is not performed. 3: The voltage is too low. 4: A sudden load is added during operation. 5: The frequency inverter model is of too small power class.	1: Eliminate external faults. 2: Perform the motor auto-tuning. 3: Adjust The voltage to normal range. 4: Remove the added load. 5: Select a frequency Inverter of higher power class.
Overvoltage during acceleration	5	Er.OU1 Er.oU1	1: The input voltage is too high 2: The surge voltage is mixed in the input power supply. 3: There is an external force to drive the motor to run, or the brake type load is too heavy 4: The acceleration time is too short 5: The motor is shorted to ground	1: The power supply voltage is reduced to the normal range 2: Install DC reactor 3: Cancel the external force of the druggable motor or install the brake unit 4: Increase the acceleration time 5: Eliminate the part of the ground short circuit
Overvoltage during deceleration	6	Er.OU2 Er.oU2	1: The input voltage is too high 2: The surge voltage is mixed in the input power supply. 3: There is an external force to drive the motor to run, or the brake type load is too heavy 4: The deceleration time is too short 5: The motor is shorted to ground	1: The power supply voltage is reduced to the normal range 2: Install DC reactor 3: Cancel the external force of the druggable motor or install the brake unit 4: Increase the deceleration time 5: Eliminate the part of the ground
Overvoltage at constant speed	7	Er.OU3 Er.oU3	1: The input voltage is too high 2: The surge voltage is mixed in the input power supply. 3: There is an external force to drive the motor to run, or the brake type load is too heavy 4: The acceleration or deceleration time is too short 5: The motor is shorted to ground	1: The power supply voltage is reduced to the normal range 2: Install DC reactor 3: Cancel the external force of the druggable motor or install the brake unit 4: Increase the acceleration or deceleration time 5: Eliminate the part of the ground

Fault Name	Fault code	Display	Possible Causes	Solutions
Low voltage	8	Er.Lv1 Er.Lu1	<p>1: Instantaneous power failure occurs on the input power supply or input phase loss</p> <p>2: The frequency inverter's input voltage is not within the allowable range.</p> <p>3: Cut off the power during operation</p> <p>4:the internal wiring of the inverter is loose, or the hardware is bad.</p>	<p>1:Check if the input power supply is abnormal, whether the input power terminal is loose, whether the input contactor or the air switch is abnormal.</p> <p>2:adjust the voltage to the normal range</p> <p>3:Power off after the inverter stops</p> <p>4:seeking technical support</p> <p>5: For the unstable power supply, if the performance requirements are low, try to enable the undervoltage stall function (P23.00).</p>
Contactor open	9	Er.Lv2 Er.Lu2	<p>1: Instantaneous power failure occurs on the input power supply</p> <p>2: The frequency inverter's input voltage is not within the allowable range.</p> <p>3: Cut off the power during operation</p> <p>4:the internal wiring of the inverter is loose, or the hardware is bad.</p>	<p>1:Check if the input power supply is abnormal, whether the input power terminal is loose, whether the input contactor or the air switch is abnormal.</p> <p>2:adjust the voltage to the normal range</p> <p>3:Power off after the inverter stops</p> <p>4:seeking technical support</p> <p>5: For the unstable power supply, if the performance requirements are low, try to enable the undervoltage stall function (P23.00).</p>
Frequency inverter overload	10	Er. Ol Er. oL	<p>1:The load is too large or the motor is blocked.</p> <p>2:The large inertia load acceleration and deceleration time is too short</p> <p>3: When the VF is controlled, the torque boost or V/F curve is not suitable.</p> <p>4:The frequency converter selection is too small</p> <p>5:Overload at low speed operation</p>	<p>1. Reduce the load and check the motor and mechanical conditions.</p> <p>2, increase the acceleration and deceleration time</p> <p>3. Adjust the torque boost or V/F curve</p> <p>4, select the inverter with a larger power level</p> <p>5. Perform motor self-learning in cold state and reduce carrier frequency at low speed</p>

Fault Name	Fault code	Display	Possible Causes	Solutions
Motor overload	11	Er.oL1 Er.oL1	<p>1:The load is too large or the motor is blocked.</p> <p>2:The large inertia load acceleration and deceleration time is too short</p> <p>3:When the VF is controlled, the torque boost or V/F curve is not suitable.</p> <p>4:The motor selection is too small</p> <p>5:overload at low speed operation</p> <p>6:Improper setting of motor parameters and motor protection parameters</p>	<p>1. Reduce the load and check the motor and mechanical conditions. Correctly set the motor parameters and motor protection parameters.</p> <p>2, increase the acceleration and deceleration time</p> <p>3. Adjust the torque boost or V/F curve</p> <p>4, select a motor with a higher power level</p> <p>5. Perform motor self-learning in cold state and reduce carrier frequency at low speed</p> <p>6, check the settings of related parameters</p>
Power input phase loss	12	Er.iLP Er.iLP	<p>1: The three-phase power input is abnormal.</p> <p>2: The drive board is faulty.</p> <p>3: Thelightning proof board is faulty.</p> <p>4: The main control board is faulty.</p>	<p>1:Eliminate external faults.</p> <p>2: Ask for technical support.</p> <p>3: Ask for technical support.</p> <p>4: Ask for technical support.</p>
Power output phase loss	13	Er.oLP Er.oLP	<p>1: The cable connecting the frequency inverter and the motor is faulty.</p> <p>2: The frequency inverter's three-phase outputs are unbalanced when the motor is running.</p> <p>3: The drive board is faulty.</p> <p>4: The IGBT module is faulty.</p>	<p>1:Eliminate external faults.</p> <p>2: Check whether the Motor three phase winding is normal.</p> <p>3: Ask for technical support.</p> <p>4: Ask for technical support.</p>

Fault Name	Fault code	Display	Possible Causes	Solutions
IGBT Module overheat	14	Er. oH Er. oH	<ol style="list-style-type: none"> 1: The ambient temperature is too high. 2: The air filter is blocked. 3: The fan is damaged. 4: The thermally sensitive resistor of the IGBT module is damaged. 5: The inverter IGBT module is damaged 	<ol style="list-style-type: none"> 1: Lower the ambient temperature. 2: Clean the air filter. 3: Replace the damaged fan. 4: Replace the damaged thermally sensitive resistor. 5: Replace the inverter module.
Motor overheat	16	Er. oH3 Er. oH3	<ol style="list-style-type: none"> 1: The temperature sensor wiring is loose 2: The motor temperature is too high 3: The motor temperature sensor detects that the temperature is greater than the set threshold. 	<ol style="list-style-type: none"> 1: check the temperature sensor wiring 2: Improve the carrier frequency, strengthen the heat dissipation of the motor, reduce the load, and select a motor with higher power. 3: Check if the set threshold is reasonable.
By wave current limiting fault	17	Er. CbC Er. CbC	<ol style="list-style-type: none"> 1: The load is too heavy or locked-rotor occurs on the motor. 2: The frequency inverter model is of too small power class 	<ol style="list-style-type: none"> 1: Reduce the load and check the motor and mechanical condition. 2: Select a frequency inverter of higher power class.
Ground short circuit	18	Er. GF Er. GF	<ol style="list-style-type: none"> 1. Motor burnout or insulation aging 2, The cable is damaged and contact, short circuit 3. The distributed capacitance of the terminal and motor cable is larger \oplus 4, Hardware is damaged 	<ol style="list-style-type: none"> 1. Confirm the insulation resistance of the motor. If it is turned on, replace the motor. 2. Check the power cable of the motor to eliminate the fault point. 3, reduce the carrier frequency, install the output reactor 4, seeking technical support
module temperature detection fault	20	Er. tCK Er. tCK	<ol style="list-style-type: none"> 1, Temperature detection line broken 2, Drive board is faulty 3. Main control board is faulty 4, The environmental temperature is too low 	<ol style="list-style-type: none"> 1. Check the thermistor wiring 2. Ask for technical support 3. Ask for technical support 4, manual intervention to drive the temperature rise
Current detection fault	21	Er. Cur Er. CUR	<ol style="list-style-type: none"> 1: The HALL device is faulty. 2: The drive board is faulty. 3: The control board is faulty 	<ol style="list-style-type: none"> 1: Replace the faulty HALL device. 2: Replace the faulty drive board. 3: Ask for technical support.

Fault Name	Fault code	Display	Possible Causes	Solutions
Encoder offline	22	Er.PGL Er.PGL	<ol style="list-style-type: none"> 1. Motor locked 2. Encoder pulse setting wrong 3. Encoder offline 	<ol style="list-style-type: none"> 1 check motor and mechanical condition 2 set correct parameter for encoder 3 check encoder connecting line
Motor over-speed	25	Er.oS Er.oS	<ol style="list-style-type: none"> 1: The encoder parameters are set incorrectly. 2: The motor auto-tuning is not performed. 3: The over-speed detection parameters are set incorrectly 	<ol style="list-style-type: none"> 1: Set the encoder parameters properly. 2: Perform the motor auto-tuning. 3: Set the over-speed detection parameter correctly based on the actual situation.
Too large speed deviation	26	Er.DEV Er.dEv	<ol style="list-style-type: none"> 1: The encoder parameters are set incorrectly. 2: The motor auto-tuning is not performed. 3: The detection parameters of too large speed deviation are set incorrectly. 	<ol style="list-style-type: none"> 1: Set the encoder parameters properly. 2: Perform the motor auto-tuning. 3: Set the detection parameters correctly based on the actual situation.
Motor auto-tuning fault 1	27	Er.tU1 Er.tU1	<ol style="list-style-type: none"> 1: The motor parameters are not set according to the nameplate. 2: The motor auto-tuning times out. 	<ol style="list-style-type: none"> 1: Set the motor parameters according to the nameplate properly. 2: Check the cable connecting between the Frequency inverter and the motor.
Motor auto-tuning fault 3	28	Er.tU3 Er.tU3	<ol style="list-style-type: none"> 1: The motor parameters are not set according to the nameplate. 2: The motor auto-tuning times out. 	<ol style="list-style-type: none"> 1: Set the motor parameters according to the nameplate properly. 2: Check the cable connecting between the Frequency
Off load	31	Er.LL Er.LL	<ol style="list-style-type: none"> 1、 The frequency inverter running current is lower than the setting value. 	<ol style="list-style-type: none"> 1、 Confirm whether the load is off 2、 Check that the load is disconnected or the parameter setting is correct
EEPROM read- write fault	32	Er.EEP Er.EEP	<ol style="list-style-type: none"> 1、 Eeprom Operate too frequent 2、 The EEPROM chip is damaged. 	<ol style="list-style-type: none"> 1、 Operate Eeprom suitable 2、 Replace the main control board
Running time arrival	33	Er.TTA Er.tTA	Inverter trial time arrival	1: Contact agent or distributor
485 Communication fault	34	Er.485 Er.485	<ol style="list-style-type: none"> 1, The work of the host computer is not normal 2, The communication line is not normal 3, The communication parameter set is incorrect 	<ol style="list-style-type: none"> 1. Check the connection of upper computer 2. Check the communication connection line 3. Set communication parameters correctly

Fault Name	Fault code	Display	Possible Causes	Solutions
PID feedback lost during running	36	Er.FbL Er.FbL	1、PID feedback<P40.35 setting value and P40.36 not zero,PID feedback>P40.37 setting value and P40.38 not zero	1、 Check PID feedback signal 2、 P40.35 and P40.37 set correct parameter
User-defined fault 1	37	Er.Ud1 Er.Ud1	1: The signal of user-defined fault 1 is input via DI. 2:The signal of user-defined fault 1 is input via virtual I/O.	1: Reset the operation. 2: Reset the operation
User-defined fault 2	38	Er.Ud2 Er.Ud2	1: The signal of user-defined fault 2 is input via DI. 2:The signal of user-defined fault 2 is input via virtual I/O.	1: Reset the operation. 2: Reset the operation
Braking feedback fault	44	Er.LF1 Er.LF1	The brake feedback function is valid, and the brake feedback signal is not detected within the time after the brake is released or after the brake is held	1. Check whether the brake feedback signal is normal 2. Check whether the time after brake release or brake is reasonable
Braking slip fault	46	Er.LF3 Er.LF3	The brake slipping hook is detected in the closed loop of the encoder	1.Check whether the brake is normal Check whether the settings of P51.23~P51.24 are reasonable



The fault code is used for the communication read fault type: when the communication reads the registers r25.00, r26.00, r26.08, r26.16, the register contents of the reply are fault coded.

6.2 Warning type

The warning is used to remind and inform the user of the current state of the inverter. When the warning occurs, the keypad will display a warning message, and the warning will automatically reset when the warning is cleared. Some warnings require the user to check the cause before running the drive, and some do not care. Warning As an instant reminder, the drive does not store the corresponding information. Bit 12 of r27.10 indicates whether there is a warning message currently.

Warning name	Warning code	Display	Reason	Measure
Insufficient power	1	PoFF PoFF	1: The DC link voltage is insufficient and cannot be started normally.	1:Check if the inverter power supply is normal.
Wrong parameter	2	A.PARA APArA	1: The parameter settings are wrong, such as: The torque mode is set in the VF control mode.	1:Modify and check the parameter compatibility problem

Warning name	Warning code	Display	Reason	Measure
Sleeping status	5	SLEEP SLEEP	1. The system is in a sleep state, and the system will automatically start when hibernation is over.	1:Generally no need to pay attention to it



The warning code is used for the communication read warning type: when the communication reads register r25.16, the contents of the returned register are the warning code.

Chapter 7 Selection Guide of inverter Accessory

7.1 Selection Guide of braking component

The braking resistor is used to consume the energy fed back by the motor to the inverter during braking or generating operation, so as to achieve quick braking or prevent the inverter from reporting the main circuit overvoltage fault. Braking resistor selection has two parameters: resistance and power, under normal circumstances, the greater the system inertia, the need for deceleration time is shorter, the more frequent braking, the braking resistor selection should be greater power, The smaller the resistance.

1、 Selection of braking units

When braking, almost all the renewable energy of motor is consumed on the braking resistor.

$$R = \frac{U^2}{P_B}$$

Formula:

U --- The braking voltage when the system brakes stably (Different models have different values. Models with built-in braking unit can be set by P22.12)

R - Braking resistor

P_B – Braking Power

2 、 Selection power of braking resistor

Braking resistor power can be calculated according to the following formula:

$$P_R = P_B \times D$$

Formula,

P_R----Braking resistor power

D ---- Braking frequency (braking process accounts for the proportion of the entire process), by the load conditions to determine the characteristics of common occasions typical values are shown in the table below:

Table 7-1 Braking frequency of common applications

applications	D value
elevator	20%~40%
Unwinding and winding	40%~60%
Centrifuge	40%~60%
Hoist and crane	40%~60%
General application	10%

3 、 braking components selection table

Table 7-2 VFD530 braking components selection table

Three phase 380V			
Model	Recommend power of braking resistor (10%braking)	Recommend resistance value of braking resistor	Braking unit
VFD530-R75GT4B	100W	≥ 200Ω	Built-in as standard
VFD530-1R5GT4B	150W	≥ 180Ω	
VFD530-2R2GT4B	300W	≥ 180Ω	
VFD530-4R0G/5R5PT4B	500W	≥ 90Ω	

VFD530-5R5G/7R5PT4B	800W	≥ 60Ω	Built-in as option
VFD530-7R5G/011PT4B	1000W	≥ 60Ω	
VFD530-011G/015PT4B	1.2KW	≥ 25Ω	
VFD530-015G/018PT4B	1.5KW	≥ 25Ω	
VFD530-018G/022PT4B	2.0KW	≥ 18Ω	
VFD530-022G/030PT4B	2.5KW	≥ 18Ω	
VFD530-030G/037PT4	3.0KW	≥ 12Ω	
VFD530-037G/045PT4	3.7 KW	≥ 15Ω	
VFD530-045G/055PT4	4.5 KW	≥ 8Ω	
VFD530-055G/075PT4	5.5 KW	≥ 6Ω	
VFD530-075G/090PT4	7.5 KW	≥ 6Ω	
VFD530-090G/110PT4~ VFD530-710GT4	As per actual load and braking power		external

7.2 PG card type

The optional PG card and supported encoders for the VFD530 are shown in the table below.

Chart 7-3 PG type view chart

Model	name	USAGE
MT500-PG-INC1	INCREMENTAL PG	open collector type, push-pull output type, differential output type encoder.
MT500-PG-INC2	Incremental encoder PG card with Frequency division	open collector type, push-pull output type, differential output type encoder. Frequency division range: 0~63
MT500-PG-RT1	RESOLVER PG	Rotary transformer encoder

(1) INCREMENTAL PG

Chart 7-4 Incremental encoder PG card (MT500-PG-INC1) port definition

Pin number diagram	Pin number	Name	Usage
	1, 10	PE	Shield terminal
	2, 11	VCC	Power output for powering the encoder 5V ± 2%, maximum 200mA 12V±5%, maximum 200mA
	3, 12	GND	Power supply common terminal and signal
	4	Z-	Encoder Z-signal
	5	Z+	Encoder Z+signal
	6	B-	Encoder B-signal
	7	B+	Encoder B+signal
	8	A-	Encoder A-signal

	9	A+	Encoder A+signal	Note:UVW is used to the synchronous motor incremental encoder, no need wiring when it is not used.
	13	W-	Encoder W-signal	
	14	W+	Encoder W+signal	
	15	V-	Encoder V-signal	
	16	V+	Encoder V+signal	
	17	U-	Encoder U-signal	
	18	U+	Encoder U+signal	

◆ **Open collector type, push-pull output type encoder wiring:**

Select the encoder power supply through SW3 on the PG card, SW1 and SW2 to the OC side, as shown below.:

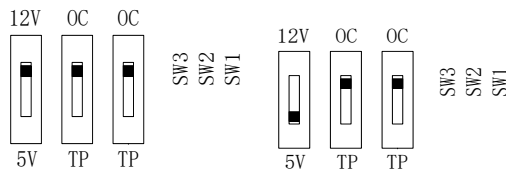

Chart 7-5 Collector open type, push-pull output type encoder DIP switch selection

When wiring, the A-, B-, Z- terminals of the PG card are not wired, and the signal output of the encoder is connected to the A+, B+, Z+ terminals of the PG card, as shown in the figure below.:

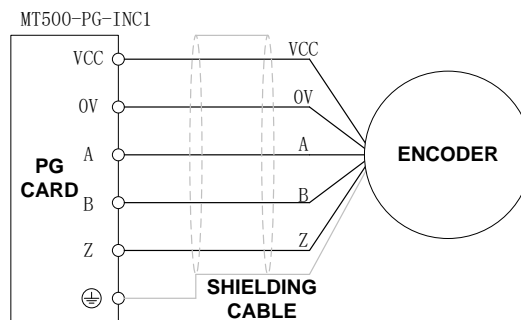

Chart 7-6 Collector open type, push-pull output type encoder wiring diagram

◆ **Differential output encoder wiring:**

Select the encoder power supply through SW3 on the PG card, SW1 and SW2 to the TP side, as shown below:

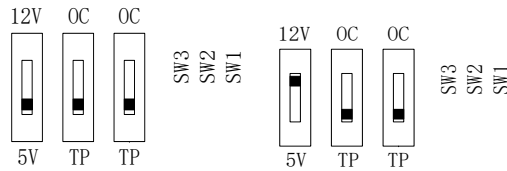

Chart 7-7 Differential output type encoder DIP switch selection

The wiring of the PG card and the encoder are connected one by one according to the silkscreen.

(2) Incremental encoder PG card with Frequency division

The input signal of the MT500-PG-INC2 crossover PG card can be differential or open collector type, selected by the DIP switch; there are two sets of output signals, open collector type and differential output type; The card's port definition is shown in the table below.

Chart 7-8 Incremental encoder PG card with frequency division (MT500-PG-INC2) port definition

Pin number diagram	Pin number	Name	Usage
	1	PE	Shield terminal
	2	VCC	Power output for powering the encoder 5V ± 2%, maximum 200mA 12V±5%, maximum 200mA
	3	GND	Power supply common terminal and signal
	4	Z-	Encoder Z-signal
	5	Z+	Encoder Z+signal
	6	B-	Encoder B-signal
	7	B+	Encoder B+signal
	8	A-	Encoder A-signal
	9	A+	Encoder A+signal
	10	OZ	Z signal crossover output (NPN open collector type)
	11	OB	B-phase pulse frequency dividing output (NPN open collector type)
	12	OA	Phase A pulse divider output (NPN open collector type)
	13	OZ-	Z signal crossover output Z- (differential output type)
	14	OZ+	Z signal crossover output Z+ (differential output type)
	15	OB-	B-phase pulse divider output B- (differential output type)
	16	OB+	B-phase pulse divider output B+ (differential output type)
	17	OA-	Phase A pulse divider output A- (differential output type)
	18	OA+	Phase A pulse divider output A+ (differential output type)

In the schematic diagram of the crossover card in Table 7-5, the dial switch indicates bit 0~bit5 of the frequency division number from right to left, the frequency division range is 0~63, and the frequency division number is set to 0 and 1 when there is no frequency division.

Frequency division corresponding to a single DIP switch

DIP switch	Number of frequency division
1	32
2	16
3	8
4	4
5	2
6	1

For example 35 frequency division: $35 = 32+2+1$

Just turn the dial switches corresponding to the subscripts 1, 5, and 6 to "ON". Please refer to the description of VFD530-PG-INC1 for encoder wiring of MT500-PG-INC2.

(3) Resolver PG card

Chart 7-9 Resolver PG Card (MT500-PG-RT1) Interface Definition

Pin number diagram	Pin number	Name	Usage
 <p>(PORT TYPE: DB9)</p>	1	EXCLO	Resolver excitation negative
	2	EXC	Resolver excitation positive
	3	SIN	Resolver feedback SIN positive
	4	SINLO	Resolver feedback SIN negative
	5	COS	Resolver feedback COS positive
	9	COSLO	Resolver feedback COS negative
	6, 7, 8	NC	Hanging in air

7.3 IO Extension card

◆ MT500-IOEX1 Extension card

The MT500-IOEX1 expansion card is a multi-function IO expansion card for VFD530 series inverters. It can expand 4 channels of DI, 2 channels of AI, and 4 channels of DO. Among them, AI4 can be used as an ordinary voltage input analog quantity, and can also be used as a temperature detection input of PT100/PT1000/KTY84-130 (temperature detection is connected to PT and COM).

The terminal definitions of the MT500-IOEX1 expansion card are shown in Table 7-10

Terminal distribution	SN	Terminal name	Terminal function description
	1、10	GND	Analog ground, internally isolated from COM
	2	AI4	Analog input 4 Input 0~10V: input impedance 22KΩ

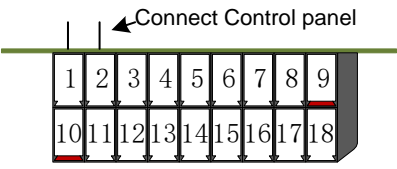
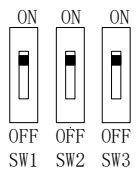
	3、6、16	COM	+24V, PT, PLC and digital input and output public terminal																			
	4	24V	Provides +24V power supply to the outside, generally used as digital input and output terminal working power supply and external sensor power supply																			
	5	PLC	Digital input power terminal																			
			It is used for switching between high and low level of switch input. It is short-circuited with +24V at the factory, that is, DI is active at low level.																			
			When the external power is input, disconnect the PLC from the +24V.																			
	It is a separate network from the PLC on the IO board and is used separately.																					
	7	PT	Support PT100/PT1000/KTY84-130 AI4 is inactive when using the temperature sensor direct connection function (temperature detection connection PT and COM)																			
			DIP switch switching mode:	<table border="1" data-bbox="981 1041 1348 1344"> <thead> <tr> <th>DIP switch</th> <th>SW 1</th> <th>SW 2</th> <th>SW 3</th> </tr> </thead> <tbody> <tr> <td>AI4</td> <td>ON</td> <td>ON</td> <td>ON</td> </tr> <tr> <td>PT100</td> <td>OFF</td> <td>OFF</td> <td>OFF</td> </tr> <tr> <td>PT1000</td> <td>OFF</td> <td>OFF</td> <td>ON</td> </tr> <tr> <td>KTY84-130</td> <td>OFF</td> <td>ON</td> <td>ON</td> </tr> </tbody> </table>	DIP switch	SW 1	SW 2	SW 3	AI4	ON	ON	ON	PT100	OFF	OFF	OFF	PT1000	OFF	OFF	ON	KTY84-130	OFF
	DIP switch	SW 1	SW 2	SW 3																		
	AI4	ON	ON	ON																		
	PT100	OFF	OFF	OFF																		
	PT1000	OFF	OFF	ON																		
	KTY84-130	OFF	ON	ON																		
	8	DI9	Digital input 9	Input frequency: 0~200Hz Voltage range: 0~30V																		
	9	DI7	Digital input 7																			
	11	AI3	Analog input 3 input 0~10V																			
	12	DO6	Open collector output 6		Voltage range: 0~24V																	
			Open collector output 4																			
Open collector output 5																						
Open collector output 3																						
17	DI8	Digital input 8	Input frequency: 0~200Hz Voltage range: 0~30V																			
18	DI6	Digital input 6																				

7.4 CANopen extension card

The MT500-CAN1 communication card is a CANopen slave communication card for connecting VFD530 series inverters to the CANopen network. Please note that CANopen communication cannot be used simultaneously with Modbus communication.

Product Features:

Support Node Guard protocol, the master station can use this function to query device status;

Support the Heartbeat protocol, and the slave station periodically reports the current status to the primary station;

Support NMT network management protocol;

SDO only supports the accelerated transfer mechanism, which can transfer up to 4 bytes and can be used to read and write the inverter parameters.

Support 4 groups of PDO

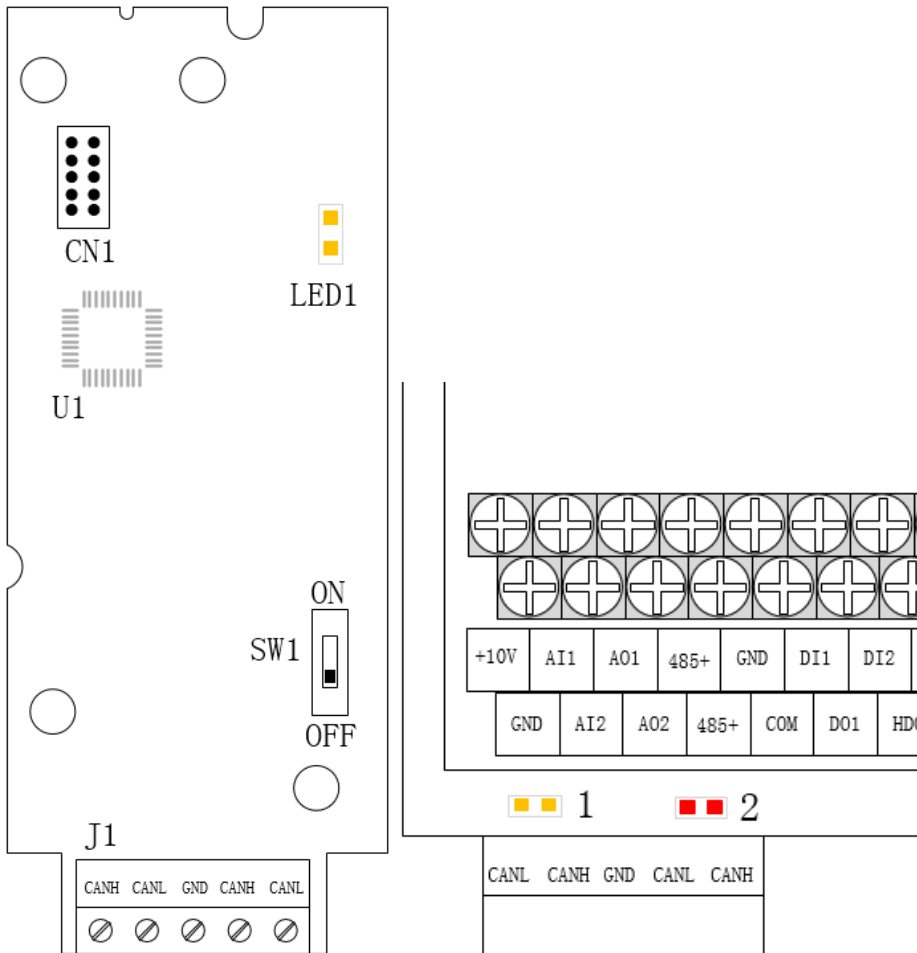

Figure 7-11 CANopen communication card and installation Diagram Table 7-12 CANopen communication card hardware description

Graphic name	Description name	Function description
J1	Terminals	CANopen bus terminal block, see description of Table 7-9
LED1	Power Indicator	Lights up to indicate normal power supply
Indicator light: Yellow light (1) Red light (2)	Status Indicator	Working status and fault indication: Yellow light (1) on: indicates normal operation Yellow light (1) flash: indicates communication initialization Red light (2) on: indicates internal communication failure Red light (2) flash: indicates CANopen communication failure or bus off
SW1	DIP switch	Terminating resistor for setting the CANopen bus

Table 7-9 Function description of J1 terminal block

Graphic name	Description name	Function description
1, 4	CANH	Signal line positive
2, 5	CANL	Signal line negative
3	GND	Signal ground

Chapter 8 Daily maintenance of frequency inverters

8.1 Daily maintenance

Due to the influence of temperature, humidity, dust and vibration, it will lead to poor heat dissipation and component aging of frequency inverter, and results in potential failure or reducing the service life of frequency inverter. Therefore, it is necessary to do daily and regular maintenance of the frequency inverter.

8.1.1 Daily maintenance

Due to the influence of temperature, humidity, dust and vibration, it will lead to poor heat dissipation and component aging of frequency inverter, and results in potential failure or reducing the service life of frequency inverter. Therefore, it is necessary to do daily and regular maintenance of the frequency inverter.

Daily check items:

- 1) Check if the sound is normal during the running of the motor;
- 2) Check if there is a vibration during the running of the motor;
- 3) check whether the installation environment of frequency inverter has changed;
- 4) Check if the cooling fan of frequency inverter is working correctly, the cooling air duct is clear;
- 5) Check if the frequency inverter is overheating;
- 6) Make sure that the frequency inverter should always be kept in a clean state;
- 7) Clear up effectively the dust on the surface of frequency inverter, prevent the dust from entering into the inside of frequency inverter, especially for the metal dust;
- 8) Clear up effectively the oil and dust on the cooling fan of frequency inverter.

8.1.2 Regular inspection

Please regularly check the frequency inverter, especially for the difficult checking place of running.

Regular inspection items:

- 1) Check the air duct and clear up regularly;
- 2) Check if there are any loose screws;
- 3) Check if the inverter has been corroded;
- 4) Check whether the wiring terminals show signs of arcing;
- 5) Main circuit insulation test.

Note: When using the megger (please use the DC 500V meg ohm meter) to measure the insulation resistance, you shall disconnect the main circuit with the frequency inverter. Do not use the insulation resistance meter to test the control circuit. It don't have to do the high voltage test (It has been done when the frequency inverter produced in factory.)

8.2 Wearing parts replacement

The vulnerable parts of the inverter mainly include cooling fans, electrolytic capacitors, relays, etc. The life of the inverter is closely related to the environment and maintenance conditions used. Table 8-3 lists the replacement time and causes of damage to the main components for reference. In addition, if abnormality is found during maintenance, please replace it in time.

Table 8-3 Spared parts replacement time

Spared parts	Replacing time	Damaged reasons	How to check
fans	30000~ 60000h	Bearing wear, blade aging	1, the blade has cracks 2 abnormal vibration, excessive noise
Electrolytic capacitor	40000~ 50000h	Poor input power quality, high ambient temperature, low air pressure, frequent load changes, electrolyte aging	1, there is liquid leakage 2, the safety valve protrudes 3, the capacitance value is beyond the allowable range 4, insulation resistance is abnormal 5, DC bus voltage fluctuations are too large
Relay	50000~ 100000 times	Corrosion, dust affect contact contact effect, contact action is too frequent	Contact ineffective

The user can refer to the accumulated power-on time and accumulated running time recorded by the inverter, and combine the actual operating conditions and the external environment to determine the replacement period.

- 1) Possible reasons for the damage of cooling fan: bearing wear and vane aging. Distinguish standard: Any cracks in the fan vanes, any abnormal vibration sound during the starting of frequency inverter.
- 2) Possible reasons for the damage of filter electrolytic capacitor: poor quality of the input power supply, the environment temperature is high, the load change frequently and the electrolyte aging. Distinguish standard: Any leakage of its liquid, if the safety valve is protruding, electrostatic capacitance and insulation resistance measurement.

8.3 Warranty Items

- 1) Warranty only refers to frequency inverter.
- 2) Under normal use, if there is any failure or damage, our company is responsible for the warranty within 18 months. (Leave factory date is subjected to the S/N on the frequency inverter nameplate or according to the contract). When over 18 months, reasonable fee will be charged for maintenance;
- 3) During the period of 18 months, if the following situation happens, certain maintenance fee will be charged;
 - a. The users don't follow the rules in the manual lead to the frequency inverter damaged;
 - b. The damage caused by fire, flood and abnormal voltage;
 - c. The damage caused by using the frequency inverter for abnormal functions;
 - d. The relevant service fee is calculated according to the manufacturer's standard, if there is an contract, then it is subject to the contract items.



For detailed warranty instructions, please refer to the Product Warranty Card.

Appendix A Modbus communication protocol

VFD530 series of inverter provides RS485 communication on interface, and adopts MODBUS communication protocol. User can carry out centralized monitoring through PC/PLC to get operating

requirements and user can set the running command, modify or read the function codes, the workingstate or fault information of frequency inverter by Modbus communication protocol. In addition VFD530 can also be used as a host to broadcast with other VFD530 communication.

A.1 Protocol format

RS485 asynchronous half-duplex.

RS485 terminal default data format: 1-8-N-1 (1 start bit, 8 data bits, no parity, 1 stop bit), the default baud rate: 9600bps. See parameter group set 30.

A.2 Message format

The VFD530 series inverter Modbus message includes the start sign, the RTU message, and the end sign.

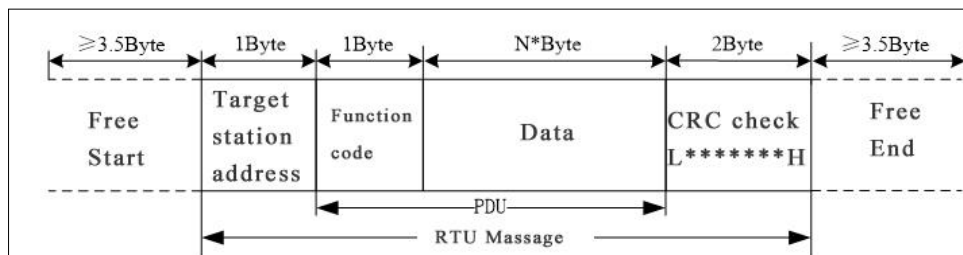

The RTU message includes the address code, the PDU (Protocol Data Unit, the protocol data unit), and the CRC check. PDU includes the function code and the data section.

RTU frame format:

Frame start (START)	More than the 3.5 byte transmission time	
Target station address (ADR)	Communication address:1 to 247(0: broadcast address)	
Command code (CMD)	Command code	Description
	0x03	Read multiple registers of the AC drive
	0x06	Write a single register to the AC drive.
	0x10	Write Multiple registers to the AC drive.
	0x08	Diagnostic command code
Number of function code	Including the register address (2Byte), the number of registers n(2Byte) and the register content (2nByte), etc.see A3 in detail	
CRC CHK low level	It indicates the replying data or the data waiting to write-in. CRC 16 check value, During the transmission, high bit is put in front and low bit is at the back. see detail in A.5 Chapter	
CRC CHK high level	It indicates the replying data or the data waiting to write-in. CRC 16 check value, During the transmission, high bit is put in front and low bit is at the back. see detail in A.5 Chapter	
FRAME END	More than 3.5 byte transmission time	

A.3 Command code instruction

A.3.1 Command code 0x03 Read multiple registers or status words● **Request PDU**

Command code	1byte	0x03
initial address	2byte	0x0000~0xFFFF(high 8 bit in front)
Number of registers	2byte	0x0001-0x0010 (1~16,high 8 bit in front)

● **Response PDU**

Command code	1byte	0x03
Initial address	1byte	2n (n means Number of registers)
Number of registers	2* nbyte	Register value high 8 bit in front,first send initial address'register value

● **Wrong PDU**

Command code	1byte	0x83
Abnormal code	1byte	See A.4Abnormal response information

Currently Modbus protocol 0x03 command code does not support cross-group read multiple function codes, it will be wrong if more than the current group of function code number

A.3.2 Command code 0x06 write single registers or status word command codes**Request PDU**

Command code	1byte	0x06
Initial address	2byte	0x0000~0xFFFF(high 8 bit in front)
Register value	2byte	0x0000~0xFFFF(register value high 8 bit in front)

● **Respond PDU**

Command code	1byte	0x06
Register address	2byte	0x0000~0xFFFF
Register value	2byte	0x0000~0xFFFF

● **Wrong PDU**

Command code	1byte	0x86
Abnormal code	1byte	See A4 Abnormal response information

A.3.3 Command 0x10 write multiple registers or status word command codes● **Request PDU**

Command code	1byte	0x10
Initial address	2byte	0x0000~0xFFFF(high 8 bit in front)
Number of Register	2byte	0x0001~0x0010(1~16, high 8 bit in front)
Number of Byte	1byte	2n (n is number of Register)

Register Value	2* nbyte	Register value high 8 bit in front, first send initial address' register value
----------------	----------	--

- **Respond PDU**

Command code	1byte	0x10
Initial address	2byte	0x0000 ~ 0xFFFF(high 8 bit in front)
Number of register	2byte	1 ~ 16(1 ~ 16, high 8 bit in front)

- **Wrong PDU**

Command code	1byte	0x90
Abnomal Code	1byte	See Abnormal response information

A.3.4 Commad code 0x08Diagnostic function

- Modbus Command Code 0x08 Provide a series of tests to check the communication system between the client (master) device and the server (slave) or various internal error conditions in the server.
- This function uses the sub-command code of 2 bytes inquiry to define the type of test to be performed. The server copies the command and subcommand codes in the normal response. Some diagnostics cause the remote device to return the data through the normally responding data fields.
- Diagnostic functions to remote devices generally do not affect the user program running in the device. The main diagnostic function of this product is not line diagnosis (0000), used to test the host from the machine is normal communication.
- Request PDU

Command code	1byte	0x08
Subcommand code	2byte	0x0000 ~ 0xFFFF
Data	2byte	0x0000 ~ 0xFFFF

Respond PDU

Command code	1byte	0x08
Subcommand code	2byte	0x0000
Data	2byte	Same as request of PDU

Wrong PDU

Command code	1byte	0x88
Abnomal code	1byte	See Abnormal response information

A.4 Abnormal response information

When the master device sends a request to the slave device, the master expects a normal response. The master's query may result in one of four events:

- (1) If the slave device receives a request for a communication error and the query can be processed normally, the slave device will return a normal response.
- (2) If the slave device does not receive the request due to a communication error, no information can be returned and the slave device times out.
- (3) If the slave device receives a request and detects a communication error (parity, address, framing error, etc.), no response is returned and the slave device times out.

(4) If the slave device receives no communication error request, but can not handle the request (such as the register address does not exist, etc.), the slave station will return an abnormal response to inform the master of the actual situation.

**Abnormal response command code = normal response command code + 0x80,
Abnormal code value and meaning as shown in the following table**

Error code	Name	Description
0x01	Invalid command code/error function code	The function code received by the slave is outside the configured range
0x02	Error data address/Illegal register address	Slave station receives the data address is not allowed address the number of registers being Read and write is out of range When writing multiple registers, the number of bytes in the PDU is not equal to the number of registers
0x03	wrong frame format	Length of frame is not correct CRC verifying not passed
0x04	Data is out of range	The data received by the slave exceeds the corresponding register minimum to maximum range
0x05	Reading request refuse	Operate to read-only register write Operate to read-only register write in running status

A.5 CRC check

CRC (Cyclical Redundancy Check) use RTU frame, The message includes an error detection field based on the CRC method. The CRC field examines the contents of the entire message. The CRC field is two bytes containing a binary value of 16 bits. It is calculated by the transmission equipment and added to the message. The receiving device recalculates the CRC of the received message and compares it with the value in the received CRC field, If the two CRC values are not equal, there is an error in the transmission. There is a lot of information on the Internet about CRC checking it is not elaborated hereabout CRC check code generation algorithm,

A.6 Register address distribution

The register address of VFD530 is 16-bit data, the upper 8 bits represent the function code group number, the lower 8 bits represent the group number, the upper 8 bits are sent before. The 32-bit register occupies two adjacent addresses, the even address stores the lower 16 bits, and the next address (odd address) of the even address stores the upper 16 bits.

In the register write operation, in order to avoid frequent damage caused by memory EEPROM write, using the highest bit of the register address indicates whether it save as EEPROM, the highest bit to be 1 indicates to save in EEPROM, 0 means save only in RAM. In other words, if you want to write the register value which is saved after power-off, you should add 0x8000 to the original register address.

VFD530 register address as follows:

Address space	Description
0x0000 ~ 0x6363 (Function code address space)	Rule: The upper 8 digits of the hexadecimal number indicate the group number (0 to 99), and the lower 8 digits indicate the serial number within the group (0 to 99).

		<p>Example 1: Function code 27.10 (drive status word 1), which The hexadecimal address is: 0x1B0A (0x1B = 27, 0x0A = 10), Decimal address: $27 \times 256 + 10 = 6922$.</p> <p>Example 2: Function code 14.01 (digital setting of torque reference), when no EEPROM is stored, its The hexadecimal address is: 0x0E01 (0x0E = 14, 0x01 = 1), The decimal address is: $14 \times 256 + 1 = 3585$.</p> <p>If you want to save the content written in communication to EEPROM after power off, then The hexadecimal address is 0x8E01 (0x0E01 plus 0x8000), The decimal address is 36353 (3585 plus 32768). Note: The addresses calculated in hexadecimal or decimal are the same, and users can choose a familiar calculation method.</p>
Communicatoin special address	0x7000	<p>Communication command. The values and functions are as follows:</p> <p>0x0000: disable command ; 0x0001: forward running; 0x0002: reverse running; 0x0003: forward jog; 0x0004: reverse jog; 0x0005: free stop; 0x0006: decelerating stop; 0x0007: immediate stop; 0x0008: fault reset;</p>
	0x7001	<p>Communication speed given. The unit of this register can be set by P30.14。</p> <p>0.01% (-100.00% ~ 100.00%) 0.01Hz (0 ~ 600.00Hz) 1Rpm (0 ~ 65535Rpm)</p>
	0x7002	<p>Communication Torque given. 0.01% (-300.00% ~ 300.00%)</p>
	0x7003	<p>Communication upper frequency given. The unit of this register can be set by P30.14. Different units range same as 0x7001.</p>
	0x7004	<p>Torque mode speed limit. The unit of this register can be set by P30.14. Different units range same as 0x7001.</p>
	0x7005	<p>Electric torque limit 0.1% (0~300.0%)</p>
	0x7006	<p>Power generation torque limit 0.1% (0~300.0%)</p>
	0x7007	<p>PID setting source. 0.01% (-100.00% ~ 100.00%)</p>
	0x7008	<p>PID feedback source 0.01% (-100.00% ~ 100.00%)</p>
	0x7009	<p>VF separation voltage given. 0.1% (0~ 100.0%)</p>
	0x700A	<p>External fault setting</p>
	0x700B	<p>DO status setting. When the DO function (please refer to P07.01 ~ P07.10) is set to 0 (no function), its status comes from the setting of the communication dedicated register, and the corresponding bit of 1 means it is valid. The bits of this register are defined as follows:</p>

		Bit7	Bit6	Bit5	Bit4	Bit3	Bit2	Bit1	Bit0
						RL2	RL1	DO2	DO1
		Bit15	Bit14	Bit13	Bit12	Bit11	Bit10	Bit9	Bit8
								VDO2	VDO1

2) Inverter status: Read the inverter status, see 27 groups of function codes.

3) Inverter fault description: read the inverter fault see 25.00 function code (0x1900)

VFD Fault address	VFD trip information	
0x1900 (25.00 function code)	0000: no fault 0001: SC protection 0002: overcurrent during acceleration 0003: overcurrent during deceleration 0004: overcurrent at constant speed 0005: overvoltage during acceleration 0006: overvoltage during deceleration 0007: overvoltage at constant speed 0008: low voltage fault 0009: contactor open 000A: VFD overload 000B: motor overload 000C: power input phase loss 000D: power output phase loss 000E: IGBT module overheat 000F: Reserved 0010: motor overheat 0011: fast overcurrent time out fault 0012: Ground fault 0013: motor auto tuning fault reserved 0014 : drives temperarure detection fault	0015: current detection fault 0016: PG card feedback fault 0017: Encoder zero detection fault 0018: Reserved 0019: overspeed 001A: too large speed deviation 001B: motor auto tuning fault 1 001C: motor auto tuning fault 2 001D: motor auto tuning fault 3 001E: motor auto tuning fault 4 001F: off load 0020: Eeprom read and write fault 0021: Reserved 0022: Communication time out fault 0023: extension card fault 0024: PID feedback lost during running 0025: User-defined fault 1 0026: User-defined fault 2

A.7 Register data type

There are several types of register data, and each type of communication setting method is shown in the following table:

Types of register data	Communication setting method
16-bit unsigned number	0~65535 corresponds to 0xFFFF; the decimal point does not need to be processed.Example: Set P00.07 to 40.00Hz: Write 0x0FA0 to the 0x0007 address.
16-bit signed number	-32768~32767 corresponds to 0x8000~0x7FFFF. Example: Set P14.01 to -50.0%: Write 0xFE0C to the 0x0E01 address.
Binary number	Represents a value of 16 bits. For example, the content of the 0x0600 address is 0x0012, which means:Bit1 of r06.00=1, bit4=1; that is, DI1 and DI5 (HDI) are valid.。
"One hundred	"Units" ~ "Thousands" correspond to 0~3bit, 4~7bit, 8~11bit,

thousand" type	12~15bit respectively. Example: Set the "Unit'digit" of P40.04 to A11 and "ten's digit" to A12: Write 0x0021 to the 0x2804 address.
32-bit unsigned number	The contents of the two registers need to be combined into 32-bit numbers. For example, read the meter r16.00: Step 1: Read 2 registers from the starting address 0x1000 Step 2: Watt-hour meter reading = ((UInt32)0x1001 value<<16) + 0x1000 value
32-bit signed number	Similar to 32-bit unsigned numbers. The value of the even address is still the lower 16 bits, and the value of the next address (odd number) of the even address indicates the upper 16 bits.

A.8 The inverter acts as a Modbus master

VFD530 can be used as a Modbus master station, it currently only supports broadcast network. When P30.09 is set as 1, master mode can be enabled. The sending frame as master station is as follows:

0x00	0x06	0x70	<u>N</u>	<u>ValH</u>	<u>ValL</u>	CRCL	CRCH
-------------	-------------	-------------	-----------------	--------------------	--------------------	-------------	-------------

Instruction:

1. N indicates the slave register of the operation which is set by P30.10.
2. Val means the data sent, Val = (ValH << 8) + ValL, the function code P30.11 is to select the contents of the data sent.
3. The idle time between frame and frame is set by function code P30.12.

Guidance for lifting function

1. Control circuit wiring

Please pay attention to the following matters when wiring:

DI3 is brake feedback, if the brake has no feedback, you don't need to connect

Relay 1 is fault signal output, and relay 2 is brake control signal output

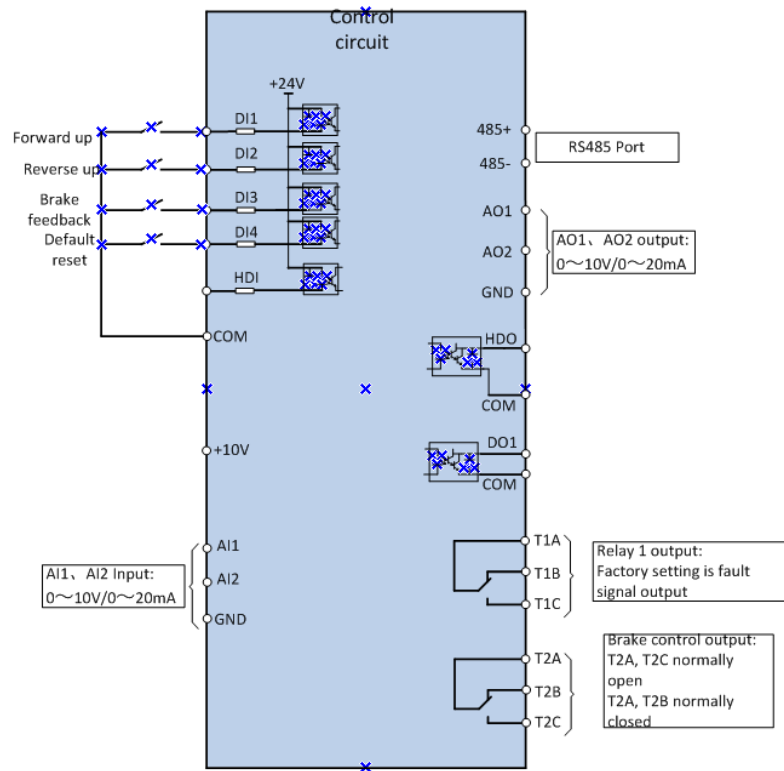

2. Confirm the direction of motor rotation

After confirming the surrounding safety, manually make the brake in the released state, press the "MK" key on the keyboard, and observe whether the direction of the motor is correct: forward transmission upwards, reverse downwards. If the direction of the motor is wrong, reverse any two connections of U, V, W.

3. Setting motor's parameters

Set following parameters according to the motor's nameplate

P11.02	Motor's rate power
P11.03	Motor's rate voltage
P11.04	Motor's rate current
P11.05	Motor's rate frequency
P11.06	Motor's rate RPM

4、 Motor self-learning

5、 Open loop self-learning

Set the motor parameters, if it is encoder closed-loop control, set the following encoder parameters

P10.01	Type of encoder
P10.02	Line number of encoder
P10.03	Encoder phase sequence

Finally set P11.10=1 and press the "RUN" key to start static self-learning.

To perform dynamic self-learning, set P11.10=2, and the motor will rotate at this time. It is best to separate the motor from the jack to avoid problems

5、 lifting adjustment

5.1 Start-stop logic

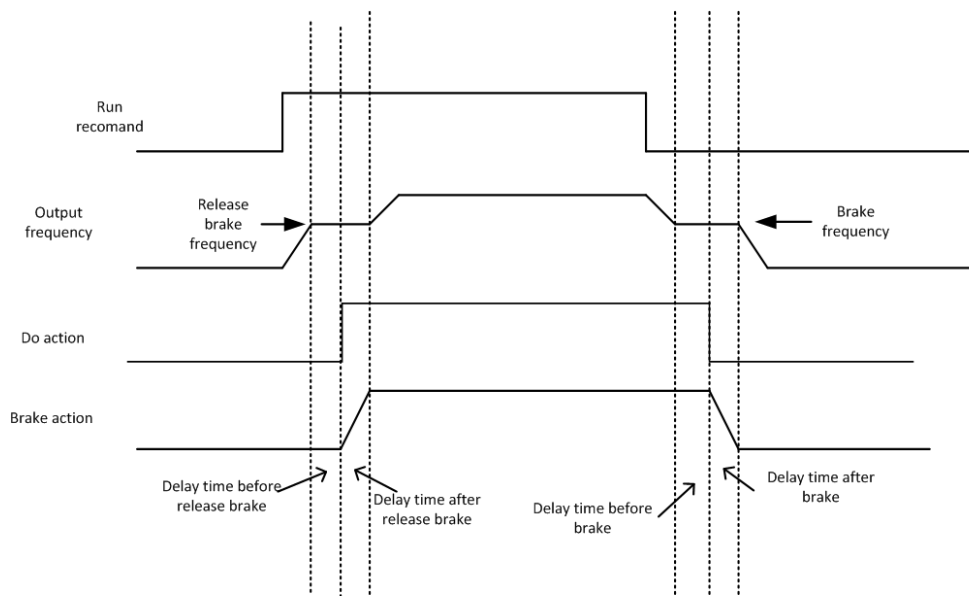

Set the function code P51.00=1 for open-loop hoisting without encoder feedback. At this time, the following parameters are set

Function code	description
P00.06=1	Terminal control
P03.01=3.00	acceleration time is 3s
P03.02=3.00	deceleration time is 3s
P23.10=10	Turn off the overvoltage stall function

P51.02 =2.00	Up release brake frequency is 2.00hz
P51.05=2.00	Down release brake frequency is2.00hz

Set P59.00=2 closed-loop lifting, with encoder feedback, the following parameters are set

Function code	description
P00.06=1	Terminal control
P03.01=3.00	acceleration time is 3s
P03.02=3.00	deceleration time is3s
P23.10=10	Turn off the overvoltage stall function
P51.02 =0.20	Up release brake frequency is 0.20hz
P51.05=0.10	Down release brake frequency is 0.10hz

➤ 5.2 Brake feedback

- If the brake has no feedback, DI3 can be disconnected, and set P51.17=0 (default is 0)
- If the brake has a feedback, connect to DI3 and set P51.17=1
- If the brake has two feedbacks, connect the brake feedback to DI3 and the brake release feedback to HDI, and set P06.05=58, P51.17=2

5.3 lifting function parameters

Symbol Description:

"☆" means that the set value of this parameter can be changed when the inverter is in stop or running state.

"★" means that the set value of this parameter cannot be changed when the inverter is running.

"●" means that the value of this parameter is the actual detection record value and cannot be changed.

Function code	Parameter name	Description	Default	Property
51 Group Lifting function special parameters				
P51.00	Lifting function selection	0: general mode 1: lifting mode	0	★
P51.01	Torque Orientation	Unit digit's: direction of brake release moment 0: The torque direction is the same as the running direction 1: The torque direction is the forward direction Tens digit's: torque direction when brake. Same as Unit digit's	11	★

Function code	Parameter name	Description	Default	Property
P51.02	Up release frequency	0.00~10.00hz	2.00hz	☆
P51.03	Up brake frequency	0.00~10.00hz, Closed loop control is invalid	2.00hz	☆
P51.04	Up release current	0.0~100.0%, Closed loop control is invalid	10.0%	☆
P51.05	Down release frequency	0.00~10.00hz	2.00hz	☆
P51.06	Down brake frequency	0.00~10.00hz, Closed loop control is invalid	2.00hz	☆
P51.07	Down release current	0.0~100.0, Closed loop control is invalid	10.0	☆
P51.08	Release brake method	0: frequency 1: frequency+ current	1	★
P51.09	delay before UP release	0.00~5.00	0.2	☆
P51.10	Delay after UP release	0.00~5.00	0.3	☆
P51.11	delay before UP brake	0.00~5.00	0.3	☆
P51.12	delay after UP brake	0.00~5.00	0.4	☆
P51.13	delay before Down release	0.00~5.00	0.2	☆
P51.14	Delay after Down release	0.00~5.00	0.3	☆
P51.15	delay before Down brake	0.00~5.00	0.3	☆
P51.16	Delay after Down brake	0.00~5.00	0.5	☆
P51.17	Brake feedback	0:no feedback 1:1 feedback 2:2 feedbacks	0	★
P51.18	Run reverse control	0: Direct reverse operation is not allowed during operation 1: Allow reverse operation during operation	0	★
P51.23	Anti-slip frequency	0.00~5.00hz	0	☆
P51.24	Anti-slip time	0.0~100.0s	1.0S	☆
P51.25	Zero crossing frequency	0.00~5.00hzWhen running from forward to reverse, when the output	2.00hz	☆

Function code	Parameter name	Description	Default	Property
		frequency is lower than the zero crossing frequency 51.25 during the deceleration process, the output frequency jumps from 51.25 to -51.25		

The DI function is increased as follows

57: brake feedback input/brake feedback input

58: brake release feedback input

The DO function is increased as follows

47: Brake control output



ShenZhen VEIKONG Electric CO., Ltd.

Factory Address: Block E01,first industrial park
lingbei 5 road ,phoenix community,fuyong street ,
Bao'anDistrict, Shenzhen ,China

TechnicalSupport Hotline: +86-0755-89587650

Web Site: www.veikong-electric.com